



INDUSTRIAL ACOUSTICS

Silencers and Noise Control Solutions



BURGESS-MANNING

A **CECO** ENVIRONMENTAL BRAND

DELIVERING CONFIDENCE IN HIGH PERFORMANCE ACOUSTICAL SOLUTIONS

CONTENT

OVERVIEW



SILENCERS & ACOUSTICAL SOLUTIONS



MARKETS



PROJECTS



OFFICES AROUND THE WORLD



Burgess-Manning, a CECO Environmental brand, has supplied a wide variety of silencer products for industrial applications since the early 1920s. We were the first company to offer a commercially produced acoustic reduction component to the market. In 2023, CECO acquired Wakefield Acoustics, Ltd., a UK-based design and manufacturing firm specializing in advanced industrial, commercial and environmental noise control systems, to provide a complete offering of noise abatement options.

Noise is often overlooked as a source of major pollution. It has been directly linked to adverse health and environmental outcomes. As companies have become aware of these issues, it has become increasingly important to provide our type of highly engineered and efficient solutions.

We specialize in providing solutions to Original Equipment Manufacturers (OEM), EPC contractors and end users. Our customers include gas turbine manufacturers, boiler suppliers, power producers and other industrial suppliers. Whether a problem can be solved from our standard products line or needs a tailor-made solution, Burgess-Manning takes control from design to installation and can even manage complex turn-key retrofit projects.

Today, we are recognized as a leading global silencer company with approximately fifty thousand acoustical solutions designed and installed at facilities worldwide, factories on every major continent. Our experience and continued research and product development efforts allow us to offer the widest selection of acoustic solutions to meet any noise problem you may encounter.

CAPABILITIES

- | | |
|-------------------------------------|--|
| 1 Exhaust Diffuser / Exhaust Plenum | 10 Diverter Damper |
| 2 Exhaust Duct | 11 Guillotine Damper |
| 3 Exhaust Bypass System | 12 CO / VOC Oxidation |
| 4 Silencer | 13 Selective Catalytic Reduction (SCR) / DeNOx |
| 5 Exhaust / HRSG Inlet Duct | 14 Peerless Patented EDGE™ AIG |
| 6 HRSG Internal Insulation | 15 Reagent Control System |
| 7 Vent Silencer | 16 Dump Tube |
| 8 Stack | 17 Inline Diffuser |
| 9 Expansion Joint | 18 18 Commissioning Silencer |

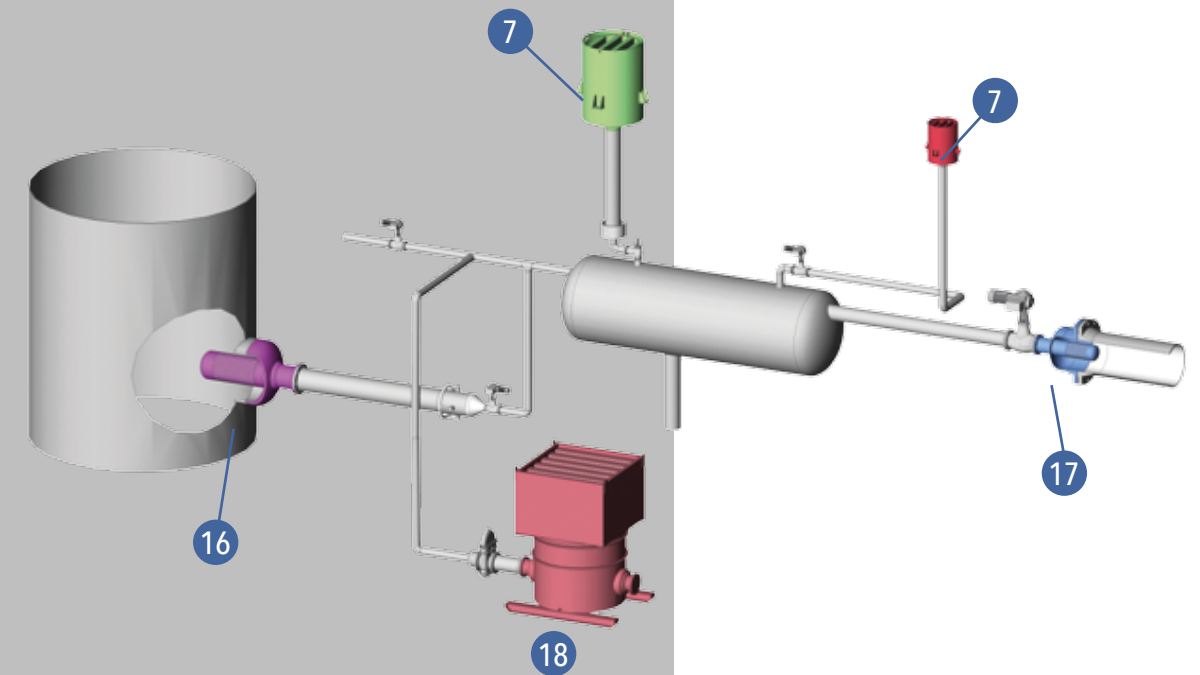
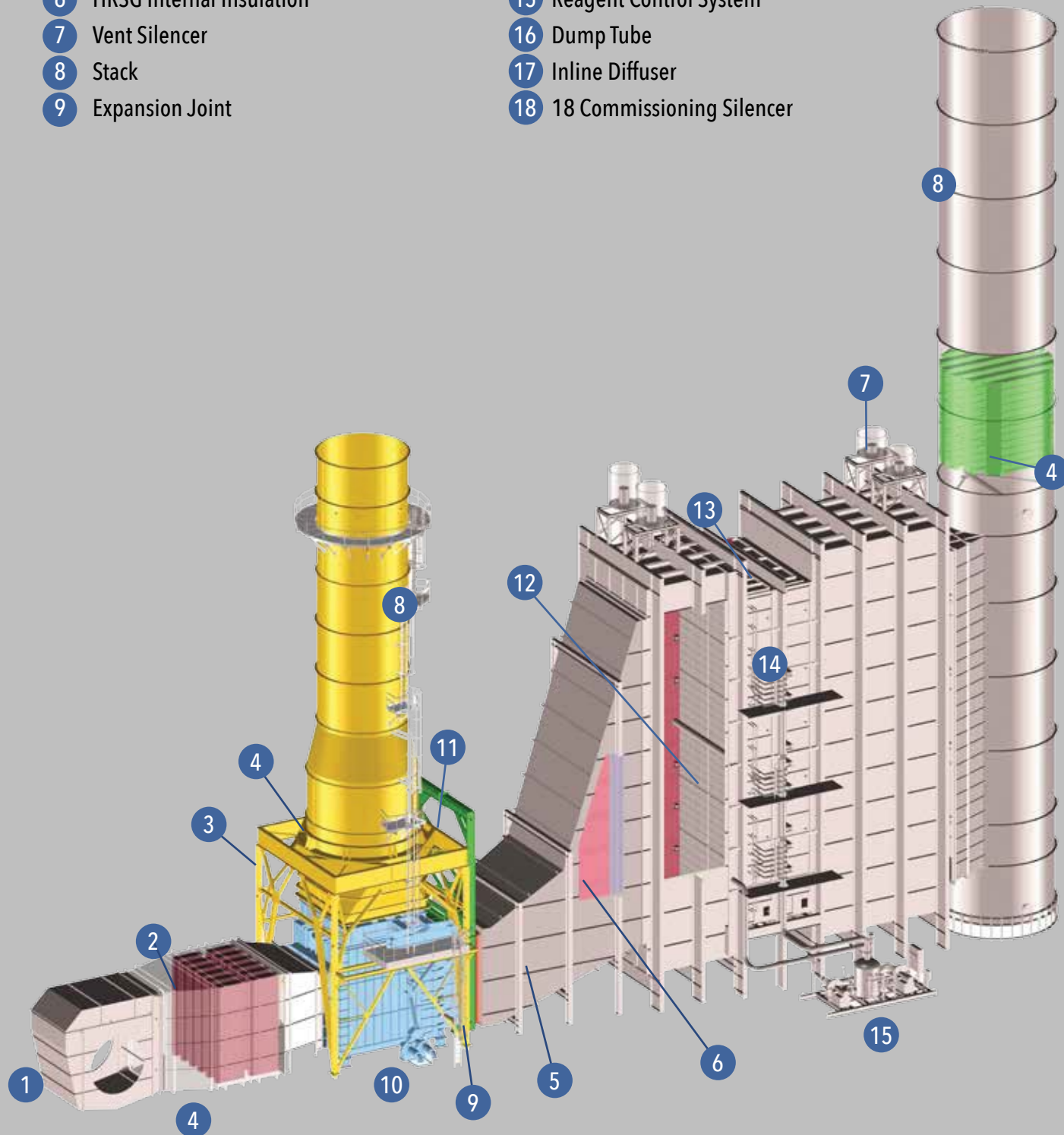

The current market environment is pushing the operational conditions of Industrial Gas Turbine systems to its limits. High cycling (high numbers of starts and stops) as well as high local flue gas velocities and temperatures are putting large stresses on the exhaust gas systems. Environmental regulations require stringent and lower noise levels on gas & steam turbine driven systems as well as on petrochemical applications.

ACOUSTICAL SOLUTIONS BURGESS-MANNING SILENCER TECHNOLOGY GROUP

- Engine Silencers
- Blowdown Separator Silencers
- Commissioning Silencers
- Inline Diffusers and Spargers
- Reactive Silencers
- Absorptive Silencers
- Vacuum Pump Separator / Silencers
- Flue Gas Silencers
- Vent / Blowdown Silencers
- Compressor Silencers
- Inline Silencers
- Blower Silencers
- Acoustical Shrouds
- Enclosures
- Filter Silencers

INNOVATIVE SILENCER SOLUTIONS

OUR ATMOSPHERIC VENT SILENCERS VENT VIRTUALLY ANY GAS.

Burgess-Manning vent silencers are typically used in conjunction with a relief/safety or start-up type valve. Applications are in heat recovery systems, steam boilers, and at oil/gas/chemical processing plants. The Burgess-Manning vent silencer effectively eliminates unwanted noise at the source and provides for low sound level discharge to the atmosphere.

Burgess-Manning vent silencers are custom-sized and designed for every application, ensuring the best acoustical performance and can be designed for as low as 500 kg/hr. (1,100 lbs./hr.) to upwards and exceeding half a million kg/hr. (1.1 million lbs./hr.). Applications: Safety and relief valves, gas vents, process gas blowdowns, boiler start-up and purge, switch valves, drain and atmospheric blowdown tanks.

Our silencers can be designed to vent virtually any gas for example:

- Steam
- Natural Gas
- Nitrogen
- Air
- Hydrogen mixed gases
- Oxygen

Commissioning Silencers

Burgess-Manning commissioning silencers are designed for temporary usage to vent down high velocity steam or air and to collect and remove possible debris present during new pipeline construction that could cause damage to downstream equipment once the pipeline is commissioned, and other equipment is installed.

Our standard model is designed to vent over half a million kg/hr (1.1 million lbs./hr.) of steam and provides 35-40 decibels of noise reduction. Additional noise reduction is achievable through an acoustical splitter package installed at the silencer outlet. This design, with the splitter package, can provide over 50 decibels of noise reduction.

IN-LINE DIFFUSERS / SPARGERS

The Burgess Manning in-line diffuser/sparger assembly is a drilled pipe component and is designed to reduce the noise typically associated with pressure reducing valve applications. These designs are especially effective when used in combination with a valve to achieve and/or share the total pressure drop required by the system. It also is effective in dissipating high energy noise and reshaping the frequency spectrum, shifting the peak frequency to a higher octave band therefore reducing the total emitted noise.

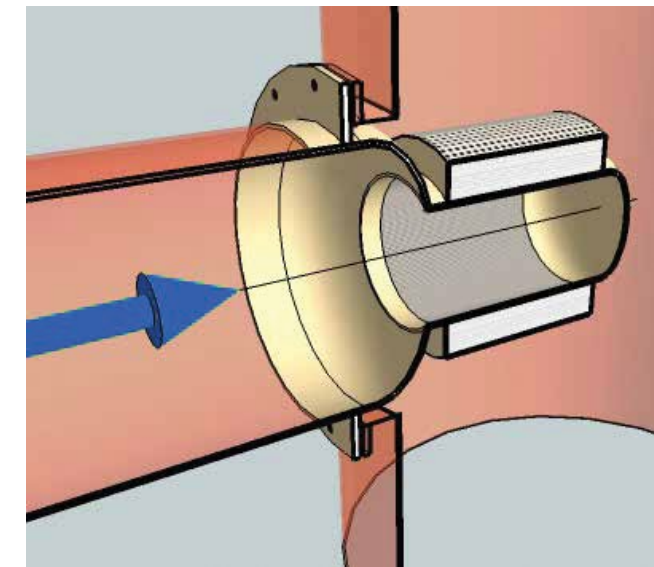



REACTIVE SILENCERS

Applications

Low to medium frequency noise reduction for:

- Intake and exhaust of reciprocating engines
- Discharge of rotary blowers and vacuum pumps
- Exhaust for reciprocating engines in marine use

Design

Gas flows through an arrangement of ported tubes and chambers which attenuates the noise over a wide frequency.



Model BEO –
Engine Exhaust Silencer

ABSORPTIVE SILENCERS

Applications

Medium to high frequency noise reduction at low pressure drop for:

- Suction and discharge for centrifugal, screw compressors and blowers
- Intakes and exhaust for gas turbines
- Upstream and downstream of pressure reduction valves

Design

Gas flows through an annular passage lined with perforated tubes backed by multiple layers of sound absorbing materials.

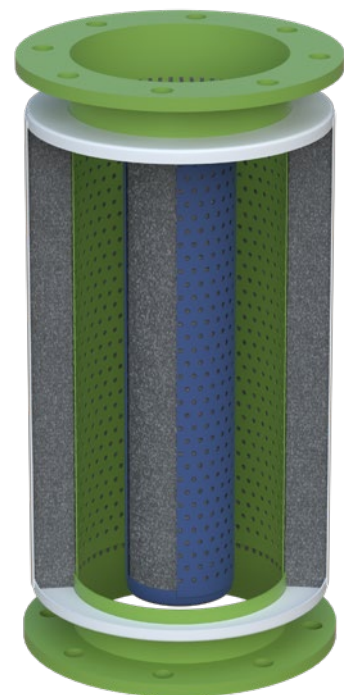

ACA Silencer

WATER SEPARATOR / SILENCERS

Applications

- Separator / Silencers for water sealed-vacuum blowers
- 99% of the free liquids are removed
- centrifugally in the separation section

Design

The Burgess-Manning design removes liquids and reduces noise. Gas flow passes through a separation section, a ported tube and snubbing chamber which attenuates the noise over a wide frequency range.



WSDA- Water
Separator Silencer

FLUE GAS SILENCERS

Applications

Medium to high frequency noise reduction at low pressure drop for:

- Hot or cold exhaust stacks, single cycle or bypass (from 1,5m (60 inches) up to 10m (390 inches) diameter)
- Ducts (Square or round)

Design

Gas flows through a Patented rectangular splitter section lined with perforated metal and backed by multiple layers of sound absorbing materials.

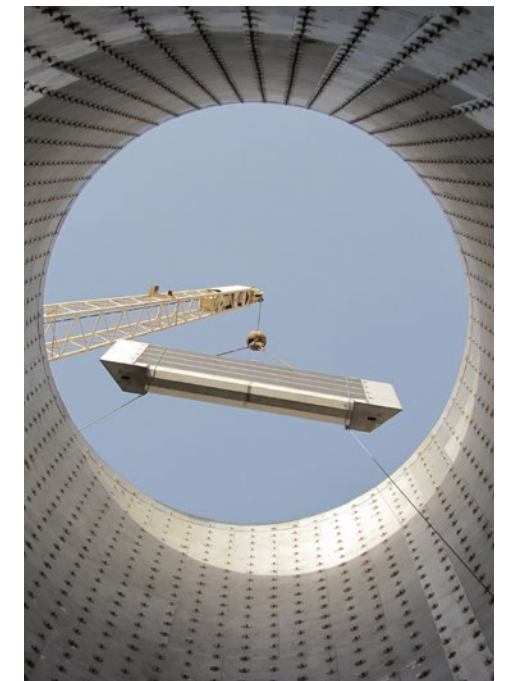

ACOUSTICAL SHROUDS AND ENCLOSURES

With increasing noise restriction requirements and the installation of large power plants close to cities and neighborhoods, acoustical panels provide an effective and economical acoustical treatment for large surface areas. These panels and lagging are particularly well suited for large surface areas like HRSG's and their inlet ducts.

Our "sandwich" design of panel is 50 to 150mm (2 to 6 inches) thick (depending on acoustical requirements) and consists of a steel galvanized in- and outside skin, acoustical filler and a perforated steel. The acoustical panels are supplied cut to size and marked, and installed with an easy interlock system with all adjacent panels. The panels are approx. 1,2m x 6m (4ft x 20ft) and will be horizontal mounted. Due to the complexity of these large projects we support you with 1-2 days in office support by our best engineers, to make sure our product meets your system requirements. Support includes engineering design review meetings and CAD-modeling of our shroud to the customer's structure if required.

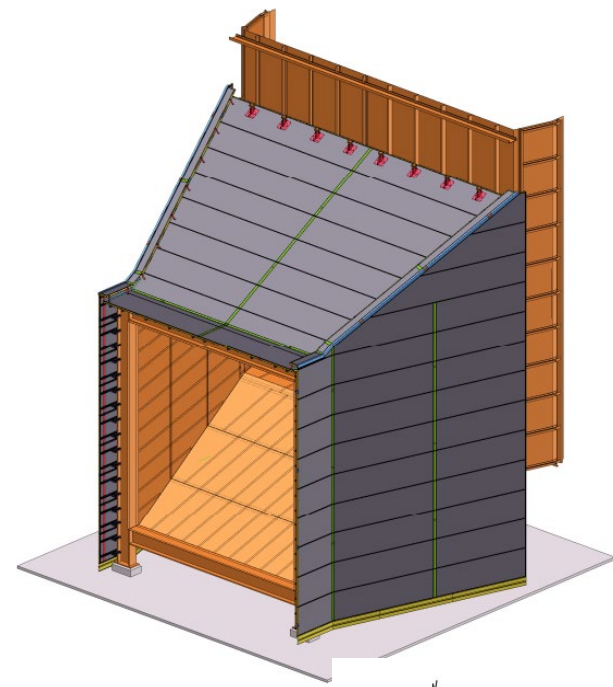

BLOWDOWN SEPARATOR SILENCER

The Burgess-Manning Blowdown Silencer / Separators are installed at Natural Gas Compressor Stations, storage facilities, and Midstream Processing Plants to provide a means of reducing the noise generated by the rapid venting of compressed gas to atmosphere either during a scheduled maintenance blowdown or an emergency blowdown scenario while also removing suspended liquids from the gas stream prior to being expelled to the atmosphere.

Burgess-Manning engineers can properly size and incorporate a restriction orifice to be installed upstream of the silencer to control the blowdown time period and/or control the rate of initial blowdown if required to protect the compressor unit from damage caused by a rapid decompression.

Available options with the Burgess-Manning Blowdown Silencer / Separators include the restriction orifice, a double domed weatherhood to minimize the potential from rain collecting in the silencer while also allowing for the gas to escape unencumbered to atmosphere, a liquid collection sump with liquid level gauge and/or liquid level switch, and a drain valve to drain the collected liquids.

The silencer / separator can be sized to a specified height and/or exit diameter to optimize the exit velocity to ensure a safe dispersion of the gas into the atmosphere.



FILTER SILENCER, SERIES A AND B AIR INTAKE CLEANING FOR ENGINES, COMPRESSORS, BLOWERS AND TURBINES

APPLICATIONS

Burgess-Manning standard Filter/Silencers (BMF) are designed for use on the air intakes compressors, blowers, engines and gas turbines.

Description

Burgess-Manning standard models in the A and B Series offers sizes ranging from 2.500 to 81.500m³/hr (1,500 to 48,000 CFM) with either single or dual stage filtration. Efficiencies range from 72% to 99% AC fine.

The assemblies can reduce intake noise from the source by up to 14 decibels and if additional acoustic reduction is required, other Burgess-Manning filter silencer elements can be added to the installation.

When it is time to change out a filter element, unique spring loading catches simplify the removal and replacement of these elements with the most common filter elements stocked by Burgess-Aarding for quick assembly and shipment directly to the jobsite.

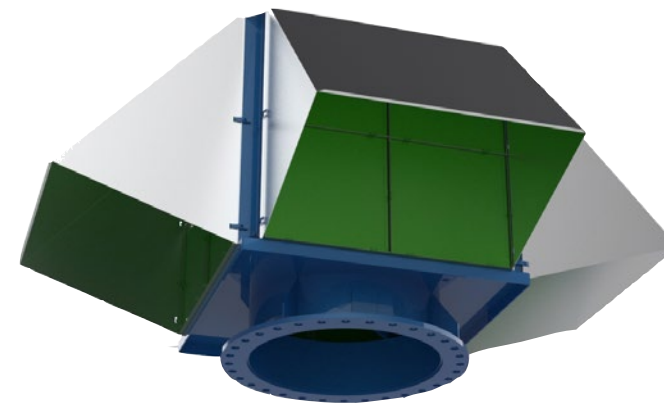

ACOUSTIC WALL / NOISE BARRIERS

Burgess-Manning's acoustic walls are engineered to reduce noise transmission by up to 50dB Rw, providing reliable noise control in industrial and commercial environments. Constructed using high-performance acoustic panels, our walls ensure effective sound attenuation while maintaining structural integrity.

Available in various thicknesses, our panels are designed to meet specific noise control requirements, ensuring optimal performance for each application. The outer casing is built from durable materials such as galvanized steel, stainless steel, or aluminum, enclosing layers of sound-absorbing mineral wool. This design effectively reduces noise while preventing issues like rot, mold, and bacterial growth.

Our acoustic walls offer a practical solution for managing noise, enhancing operational efficiency, and creating a more comfortable environment. With customizable options to suit different projects, Burgess-Manning ensures superior noise control tailored to your needs.



MARKETS

BURGESS-MANNING PROVIDES PRODUCTS AND SERVICES TO ALL INDUSTRIAL MARKETS INCLUDING:

- Power Generation
- Midstream Oil & Gas
- Downstream Oil & Gas
- Aero Engine Test Cell
- Mining
- Pulp & Paper
- Chip Manufacturing
- Data Centers
- Attraction Parks
- Water Treatment Facilities
- Battery Manufacturing

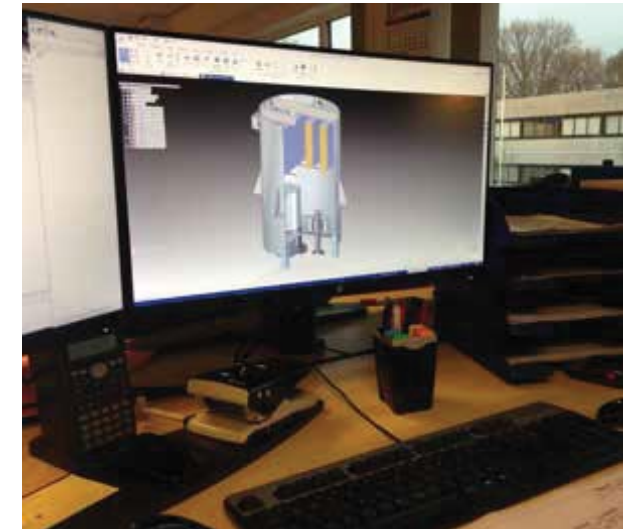



- A Burgess-Manning office
- Projects

BURGESS-MANNING PROJECTS

“Our strength comes from our extensive know-how on a wide variety of acoustical products.”

NORTH AMERICA

- Wayne County, North Carolina
Supply Of Vent Silencers
- Lackawana, Jessup Pennsylvania
Supply Of Vent Silencers, Flue Gas Silencers
- Okeechobee, Florida
Supply Of Vent Silencers, Flue Gas Silencers
- Fort Myers, Florida
Supply Of Inline Diffusers, Vent Silencers
- Greenfield, Ottawa Canada
Supply Of Vent Silencers
- Temple & Sherman, Texas
Supply Of Vent Silencers
- Richmond Energy Centre, Philadelphia
Supply Of Vent Silencers
- Oxymar, Gregory Texas
Supply Of Natural Gas Blow Down Silencers
- Nicor Gas, Streator Illinois
Supply Of Natural Gas Blow Down Silencers
- Colerain Compressor Station, Dillonvale Ohio
Supply Of Natural Gas Blow Down Silencers
- Salineville - Tx Eastern Transmission, Ohio
Supply Of Natural Gas Blow Down Silencers
- Algonquin Gas Transmission, Weymouth Massachusetts
Supply Of Natural Gas Blow Down Silencers

- Texas Eastern Transmission Lp, Summer Shade Kentucky
Supply Of Natural Gas Blow Down Silencers
- Bedford/Tx Eastern Transmission, Bedford Pennsylvania
Supply Of Natural Gas Blow Down Silencers
- Cpg Grayson Metering Station, Grayson Kentucky
Supply Of Natural Gas Blow Down Silencers
- Carrol County, Ohio
Supply Of Spargers
- Moxie Energy, Lucerne County Philadelphia
Supply Of Spargers

LATIN & SOUTH AMERICA

- Belgrano & San Martin, Argentina
Supply Of Vent Silencers
- Pilar, Buenos Aires Argentina
Supply Of Vent Silencers, Flue Gas Silencers
- Termoflorres, Bogota Colombia
Supply Of Vent Silencers
- Manzanillo, Mexico
Supply Of Vent Silencers, Flue Gas Silencers
- Tuxpan, Mexico
Supply Of Vent Silencers
- Empalme I & II, Empalme Mexico
Supply Of Vent Silencers
- Termodilia, Venezuela
Supply Of Vent Silencers, Flue Gas Silencers

AFRICA

- Altamira, Mexico
Supply Of Vent Silencers
 - Red Dragon, Antofagasta Chili
Supply Of Vent Silencers
 - Shell Offshore, Mexico
Supply Of Inline Diffusers
- ## EUROPE
- Schiphol Airport, The Netherlands
Supply Of Aircraft Engine Test Cell
 - Te-to Zagreb, Croatia
Supply Of Flue Gas Silencers
 - Mittelbrunn, Germany
Supply Of Vent Silencers
 - Stolberg, Germany
Supply Of Vent Silencers
 - Mongstad, Norway
Supply Of Vent Silencers
 - Zabzip, Tobolsk, Russia
Supply Of Vent Silencers
 - Tuapse, Russia
Supply Of Flue Gas Silencers
 - Derby, Uk
Supply Of Vent Silencers
 - Volta, Istanbul Turkey
Supply Of Vent Silencers, Flue Gas Silencers
 - Megalopolis, Greece
Supply Of Vent Silencers
 - Öresundsverket, Sweden
Supply Of Flue Gas Silencers

AFRICA

- Ain Beni Mathar, Marocco
Supply Of Vent Silencers
 - Arzew, Algeria
Supply Of Flue Gas Silencers
 - Kureimat, Egypt
Supply Of Flue Gas Silencers
 - Cairo North, Egypt
Supply Of Vent Silencers
 - Takoradi, Ghana
Supply Of Flue Gas Silencers
 - Talkha, Egypt
Supply Of Flue Gas Silencers
- ## MIDDLE EAST & INDIA
- PP13/PP14, Riyadh Saudi Arabia
Supply Of Vent Silencers, Flue Gas Silencers
 - Hail, Saudi Arabia
Supply Of Vent Silencers, Flue Gas Silencers
 - PP12, Riyadh Saudi Arabia
Supply Of Vent Silencers
 - Fujairah, United Arab Emirates
Supply Of Vent Silencers
 - Rabigh 6, Saudi Arabia
Supply Of Vent Silencers
 - Shuqaiq, Jazan Saudi Arabia
Supply Of Vent Silencers
 - Sohar, Oman
Supply Of Vent Silencers

- Mundra, India
Supply Of Vent Silencers
- Umm Lulu, Abu Dhabi United Arab Emirates
Supply Of Flue Gas Silencers
- Sipat, India
Supply Of Vent Silencers
- Raipur, India
Supply Of Vent Silencers
- Jazan, Saudi Arabia
Supply Of Vent Silencers
- Samalkot, India
Supply Of Vent Silencers
- Yanbu, Saudi Arabia
Supply Of Vent Silencers

ASIA

- Gulf A B, Thailand
Supply Of Vent Silencers
- Vinh Tan, Vietnam
Supply Of Vent Silencers
- Mongduong 1 & 2, Vietnam
Supply Of Vent Silencers
- Seng Kang, Indoneie
Supply Of Vent Silencers
- Karabatan, Kazakhstan
Supply Of Vent Silencers

- Navoi, Uzbekistan
Supply Of Vent Silencers
- Jimah East, Jimah Power Plant Malaysia
Supply Of Vent Silencers
- Amata Bang Pakong, Thailand
Supply Of Vent Silencers
- Jeju, South Korea
Supply Of Commissioning Silencers & Vent Silencers
- Keppel, Singapore
Supply Of Vent Silencers
- Bang Pa, Bangkok Thailand
Supply Of Vent Silencers
- Tanjung Bin, Malaysia
Supply Of Vent Silencers
- Mae Moh, Vietnam
Supply Of Vent Silencer
- Rapid, Kuala Lumpur Malaysia
Supply Of Vent Silencer

AUSTRALIA & NEW ZEALAND

- Pinjarra I & II, Australia
Supply Of Flue Gas Silencers
- Rio Tinto, Australia
Supply Of Spargers
- Yarwun, Australia
Supply Of Vent Silencers
- Huntly, New Zealand
Supply Of Flue Gas Silencers



CECO ENVIRONMENTAL is a leading environmentally focused, diversified industrial company whose solutions protect people, the environment, and industrial equipment across the globe, serving a broad landscape of industrial air, industrial water and energy transition markets. It is listed in NASDAQ (ticker symbol: CECO).

cecoenviro.com
info@OneCeco.com



 BurgessManning.com

 BurgessManning@onececo.com

Headquarter - The Netherlands

Elspeterweg 22, 8071 PA, Nunspeet, The Netherlands - (+31) 341 74 43 69

Office USA - New York

2711 Transit Road Suite 125, Elma, NY 14059 - (+1) 716 662 6540

Office Asia Pacific- Singapore

No. 34 Boon Leat Terrace, #04-19 | Singapore 119866 - (+65) 6472 0020