

# CECO Sethco

*2500 series*

**Magnetic Drive, Seal-less Chemical Pumps**

OPERATION MANUAL

*END SUCTION AND SELF PRIMING MODELS*

***SELF PRIMING***

- PMSP-2505
- KMSP-2505
- PMSP-2510
- KMSP-2510
- PMSP-2525
- KMSP-2525
- PMSP-2550
- KMSP-2550

***END SUCTION***

- PM-2505
- KM-2505
- PM-2510
- KM-2510
- PM-2525
- KM-2525
- PM-2550
- KM-2550



# CECO Sethco

700 Emlen Way • Telford, PA 18969  
Phone: 215.723.8155  
Email: info@ceco.com  
www.cecoenviro.com

## SAFETY RULES FOR SETHCO PUMPS

**CONGRATULATIONS!** You have just purchased a Sethco Pump, a quality industrial product manufactured to exacting standards.

To insure prolonged life of your purchase, please take a few minutes to review the operating instructions and become familiar with the pump.

Thank you for choosing a Sethco product. We look forward to serving your future requirements for quality industrial corrosion resistant pumps and filter supplies.

- 1. KEEP BYSTANDERS AWAY** - All unauthorized persons should be kept a safe distance from work area.
- 2. WEAR APPROPRIATE PROTECTIVE APPAREL.**  
Such as gloves, aprons, footwear and faceshields, etc. when installing, operating or maintaining the unit.
- 3. KEEP HANDS AND FINGERS FROM IMPELLER.**
- 4. KEEP FACE AWAY** - Don't look into hose, pump discharge, or suction.
- 5. AUXILIARY EQUIPMENT** - Hoses must be suitable for the chemical to be transferred. They must also be selected to safely contain the pressure at the operating temperature. Clamps must not be attacked by any corrosive environment or splashing.
- 6. DO NOT USE FOR** - any other application unless written permission is obtained from the factory.
- 7. ALL CONNECTIONS** - should be checked for secure and leakproof fit.
- 8. NEVER** - Turn pump on unless valves are open.
9. When wiring motor, follow all electrical safety codes.
10. Always disconnect power source before performing work on or near the motor or its connected load. Lock it in the open position and tag it to prevent unexpected application of power. Failure to do so could be fatal.
11. Avoid touching exterior of motor. It may be hot enough to be painful or cause injury. With modern motors this condition is normal if operated at rated load and voltage - modern motors operate at higher temperatures.
12. Protect the power cable from sharp objects. Do not kink power cable and never allow the cable to come in contact with oil, grease, hot surfaces, or chemicals.
13. Do not handle the unit with wet hands or when standing in water as electrical shock could occur. Disconnect main power before handling unit for **ANY REASON!**
14. Isolate pump by closing suction and discharge valves prior to any maintenance. Attach lockouts to valves to prevent accidental opening.
15. No piping or foundation strains on pump are permitted. Any strain will cause misalignment and early failures.
- 16. INSTALLATION - OPERATION - MAINTENANCE** of this equipment must be performed by trained and qualified personnel. Unauthorized handling of this equipment can be hazardous.

# CECO Sethco

700 Emlen Way • Telford, PA 18969  
Phone: 215.723.8155  
Email: [infofhs@onececo.com](mailto:infofhs@onececo.com)  
[www.cecoenviro.com](http://www.cecoenviro.com)

## TERMS AND CONDITIONS OF SALE

The terms and conditions stated below and on the face of any Met Pro Corp., Sethco Div. (referred to below as Sethco) quote or order form govern, and any order is accepted subject thereto. These terms and conditions supersede any terms and conditions on buyer's quote or order form or attachments thereto which are inconsistent with the provisions hereof.

**Prices:** All prices and specifications are subject to change without notice. Prices charged will be those in effect at time of shipment.

**Orders:** All orders are subject to acceptance by Sethco at its home office in Hauppauge, New York. All errors, clerical or other-wise, are subject to correction. When total net billing for material is less than the minimum charge in effect at the time of shipment, invoicing will be made at the minimum charge. Acceptance of all orders is subject to credit approval.

**Taxes:** Sethco's prices do not include sales, use or excise taxes. Consequently, in addition to the price quoted, the amount of any present or future taxes based on sale, use, manufacture or transportation shall either be paid by the buyer or the buyer shall provide Sethco with an acceptable exemption certificate. **Terms:** Terms of payment are net 30 days, F.O.B. Hauppauge, New York, unless otherwise stated on the face of any quote or order form.

**Shipments:** Scheduled shipping dates are approximate. Title to and risk of loss for the material shall pass to the buyer upon delivery thereof by Sethco to the carrier or delivery service.

**Cancellation**—All orders upon

acceptance by Sethco cannot be canceled without Sethco's written consent, and then only upon payment to Sethco of reasonable and proper cancellation charges.

**Returns:** No goods may be returned unless authorization in writing has been received from Sethco's home office. After authorization is received, all goods must be returned, freight prepaid, to our home office in Hauppauge, New York.

**Warranty:** Sethco warrants (unless otherwise written on the face of any quote or order form) that products of Sethco's manufacture are free of defects in material or workmanship. Any part, except as indicated below, proven to be defective within one year from date of shipment, after inspection by and to the satisfaction of Sethco, will be repaired or replaced free of charge, F.O.B. Hauppauge, New York. on return of such claimed defective part as outlined under "Returns" above. Excluded are Carboy and Drum pumps, which are warranted for 180 days. Also excluded are all used and/or reconditioned items and parts which carry no warranty, and all normal wearing parts such as, but not limited to, shafts, mechanical seals, bearing, gaskets, etc.

The liability of Sethco under this warranty, whether the claim is based on contract or negligence, shall in no case exceed the cost of repairing or replacing the part as herein provided, and upon expiration of the warranty period, all such liabilities shall terminate.

Sethco assumes no liability for equipment which has been tampered with or altered in any way, or for consequential loss or damage of

any kind, and the buyer, by acceptance of such equipment, assumes all liability for the consequences of its use or misuse by the buyer, his employees, or others.

**UNLESS THE BUYER HAS FURNISHED SETHCO WITH COMPLETE INFORMATION REGARDING THE INTENDED APPLICATION AND SERVICE REQUIREMENTS OF THE ITEMS ORDERED, SETHCO GUARANTEES ONLY THE IDENTITY OF THE MATERIALS USED IN THE CONSTRUCTION OF THE EQUIPMENT SHIPPED.**

Within the meaning of this warranty a defect in any part of the equipment shall not operate to condemn the entire unit when such part is capable of being renewed, repaired or replaced. Sethco assumes no field expense for service or parts on equipment without written authority from Sethco. Sethco does not warrant motors, gauges, electrical control equipment or other products not manufactured by Sethco, such being subject to warranties as may be given by their respective manufacturers.

The foregoing warranty is made in lieu of all other warranties, guarantees, obligations or liabilities, expressed or implied, by Sethco or its representatives. All statutory or implied warranties, other than of title, are hereby expressly negated and excluded. All illustrations and provisions in specifications are descriptive and are not intended as warranties.

Since the policy of Sethco is one of continual improvement, we reserve the right to change design or materials at any time, without giving notice or creating any obligation to

**Now ORDER Sethco products ONLINE at [www.sethco.com](http://www.sethco.com)**

**END SUCTION  
MAGNETIC DRIVE  
SEAL-LESS PUMP**

**CECO Sethco**

700 Emlen Way • Telford, PA 18969

Phone: 215.723.8155

Email: [infofhs@onececo.com](mailto:infofhs@onececo.com)

[www.cecoenviro.com](http://www.cecoenviro.com)

*For high volume transfer  
of most acids, alkalies, caustics,  
bleaches, sea water, solvents  
and many other harsh environments*



**WARNING: PUMP CONTAINS POWERFUL  
MAGNETS. EXTREME CARE MUST BE USED  
DURING ASSEMBLY AND  
DISASSEMBLY TO AVOID INJURY.**

# OPERATING INSTRUCTIONS

## **YOU WILL NEED THE FOLLOWING TOOLS**

1. 3/8" ratchet
2. 3/8" 6" length extension
3. Torque wrench
4. 9/16" socket
5. 3/4" socket
6. 3/4" open end wrench
7. 1/8" hex allen wrench
8. 7/16" deep socket
9. Teflon paste (optional)
10. Sethco removal tool (part number: 914P102543-680 (optional))

## **INSTALLATION**

Allow sufficient head room and floor space for proper inspection and maintenance.

## **PIPING**

All piping must be supported independently of the pump. The piping should always line up naturally with the pump. Never draw or force the piping to the suction or discharge of the pump. All installations should be properly designed for changes in ambient operating temperatures. *Omission of this could result in severe strain transmitted to the pump.*

The piping should be as short and direct as possible. Avoid all unnecessary elbows, bends, and fittings, as they increase friction losses in the piping.

## **SUCTION PIPING**

The length of the suction pipe should be as short as possible.

## **SUCTION PIPING MUST BE AIR TIGHT**

## **DISCHARGE PIPING**

A valve in the discharge line should be of a design to allow throttling or flow control. Centrifugal pumps should never be throttled on the suction side.

## **INITIAL START UP**

On first start up, and any time motor is reconnected to an electrical outlet, check direction of motor rotation as follows:

1. Fill pump with liquid as directed in priming instructions below.
2. Turn switch "on" and then "off" immediately. Observe rotation. It should be in the direction of the arrow on motor or pump (counterclockwise when looking at pump end of motor).
3. To reverse rotation refer to instructions on motor.

## **PRIMING AND STARTING**

1. **Flooded Suction** - Open all valves in suction and discharge lines. When pump is completely filled with liquid, turn motor on. Sometimes, especially when pumping higher

specific gravity liquids, the pump cannot start pumping with an open discharge line. To overcome this, simply close the discharge valve after the pump is filled with liquid, then turn on motor. Wait several seconds for pressure to build up, then slowly open discharge valve to desired flow.

2. **Non-Flooded Suction** - Place the suction line under the surface of the liquid to be pumped. Slowly fill the pump and suction line from the discharge. Make sure that no entrapped air remains. Close the discharge valve. Turn on motor. Wait several seconds for pressure to build up. Slowly open discharge valve to desired flow.

## **TROUBLESHOOTING**

### **A. Pump will not prime or insufficient liquid delivered:**

1. Air leakage in suction piping.
2. Suction lift too high or insufficient suction pressure.
3. Impeller, casing, suction pipe or strainer plugged with solids
4. Wrong rotation.
5. Magnetic couple slipping.

### **B. Not enough pressure:**

1. Speed too low.
2. Air or gases in the liquid.
3. Check impeller diameter.
4. Mechanical defects (impeller clearance too great: impeller damaged).
5. Wrong rotation.
6. Pressure gauge in the wrong place, (or defective gauge) .

### **C. Pump takes too much power:**

1. Speed too high.
2. Head lower than rating; pumping beyond design point.
3. Liquid heavier than specified; check viscosity and specific gravity.
4. Mechanical defects (rotating element rubbing).

### **D. Pump is noisy:**

1. Hydraulic noises—cavitation, insufficient suction pressure.
2. Mechanical defects (rotating parts are binding, loose or broken).

### **E. Pump leaks:**

1. Teflon o-rings are subject to creep. When a leak is detected, stop the pump and check the clamps and fasteners to be sure they are secure. Should the leak continue, secure the pump and inspect all the components for cracks and wear.

# PARTS LIST

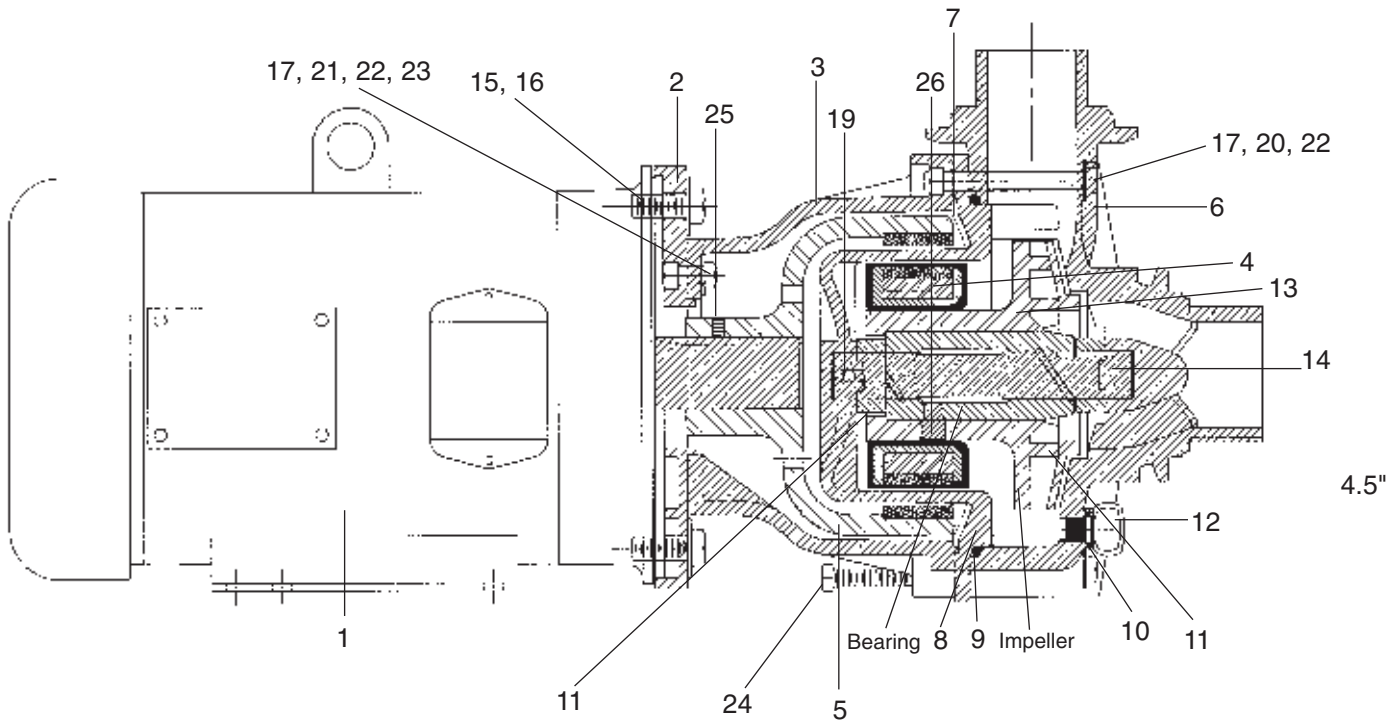

### POLYPROPYLENE MODELS

### KYNAR MODELS

ITEM	DESCRIPTION	QTY.	MATERIAL	PART NUMBER	MATERIAL	PART NUMBER
1	MOTOR	1	VARIOUS	CONSULT FACTORY	VARIOUS	CONSULT FACTORY
2	Adapter Plate	1	Noryl	010P400355-513	Noryl	010P400355-513
3	Adapter	1	Noryl	010P400356-513	Noryl	010P400356-513
4	Magnet Assembly	1	Kynar	562P400360-383	Kynar	562P400360-383
5a	MAGNETIC DRIVE - 1-1/8"	1	VARIOUS	561P4003622-362	VARIOUS	561P4003622-362
5b	MAGNETIC DRIVE - 1-3/8"	1	VARIOUS	562P4003623-362	VARIOUS	562P4003623-362
6	Casing	1	Polypro	133P400357-576	Kynar	133P400357-383
7	DISK	1	Powder Coated Stainless Steel	250P400372-685	Powder Coated Stainless Steel	250P400372-685
8	Cup	1	Polypro	180P400381-569	Kynar	180P400385-389
9	O-ring	1	Viton	590P2366-830	Viton	590P2366-830
10	O-ring	1	Viton	590P2113-830	Viton	590P2113-830
11	THRUST Washer	2	Silicone Carbide	990P202080-755	SILICONE CARBIDE	990P202080-755
12	Drain Plug	1	Polypro	660P2020651-576	Kynar	660P2020651-383
13	Impeller Assembly	1	Graphite/Polypro	consult factory	Graphite/Kynar	consult factory
14	Shaft	1	Silicone Carbide	850P202079-755	Silicone Carbide	850P202079-755
15	Screw 1/2" x 1-1/4"	4	Stainless Steel	790P0413102-680	Stainless Steel	790P0413102-680
16	Washer 1/2"	4	Stainless Steel	990P04102-680	Stainless Steel	990P04102-680
17	Washer 3/8" x 7/8"	10	Stainless Steel	990P0307-680	Stainless Steel	990P0307-680
18	Cutwater (NOT SHOWN)	1	Polypro	183P4003613-576	Kynar	183P4003613-383
19	Pin (NOT SHOWN)	1	Ceramic	682P102526-150	Ceramic	682P102526-150
20	Bolt 3/8-16 x 3-3/4"	6	Stainless Steel	790P0316306-680	Stainless Steel	790P0316306-680
21	Bolt 3/8-16 x 1"	4	Stainless Steel	790P03161-680	Stainless Steel	790P03161-680
22	Nut 3/8-16	10	Stainless Steel	610P0316-680	Stainless Steel	610P0316-680
23	Lockwasher 3/8"	4	Stainless Steel	540P03-680	Stainless Steel	540P03-680
24	Bolt 3/8"-16 x 3" (full thread)	3	Stainless Steel	790P031632-680	Stainless Steel	790P031632-680
25	Set Screw 1/4-20 x 1/2"	2	Steel	800P022004-720	Steel	800P022004-720
26	Impeller Pin	1	Kynar	682P102527-383	Kynar	682P102527-383
27a	Bearing	1	Carbon	080P202078-100	Carbon	080P202078-100
27b	Bearing	1	Silicone Carbide	080P202078-755	Silicone Carbide	080P202078-755

#### SPECIAL DRIVE BELL REMOVAL TOOL

Stainless Steel.....Part Number 914P102543-680

**NOTE 1:** POLYPROPYLENE IS GLASS REINFORCED.

**2.** O-RINGS ALSO AVAILABLE IN EPDM AND TEFLON, CONSULT FACTORY

#### IMPELLER MODEL # ASSEMBLY BEARING MATERIAL

IMPELLER MATERIAL	MODEL	CARBON	SILICONE CARBIDE
POLYPRO	2510	CONSULT FACTORY	CONSULT FACTORY
	2525	CONSULT FACTORY	CONSULT FACTORY
	2550	CONSULT FACTORY	CONSULT FACTORY
KYNAR	2510	CONSULT FACTORY	CONSULT FACTORY
	2525	CONSULT FACTORY	CONSULT FACTORY
	2550	CONSULT FACTORY	CONSULT FACTORY

#### Torque Specs

Casting - Cup	10 ft. lbs.
Adapter - Plate	10 ft. lbs.
Adapter - Motor	20 ft. lbs.

## ASSEMBLY: WET END SUBASSEMBLY

1. Lay cup (8) flat on table. Open end up.
2. Insert pin (19) into shaft (14) (unless pin is pre-molded in shaft).
3. Slide pin/shaft assembly into cup (8) with the pin guiding into the slot in the cup. **See Figure 1.**
4. Take 1 washer (11) with the cut section down and gently slide it over shaft. Slot in washer should engage standing section in cup. **See Figure 2.**
5. Press bearing (27) into impeller (28) with the guide hole in bearing lined up with the guide hole in the impeller. **See Figure 3.**
6. Place pin (26) into hole between bearing and impeller precisely pressed together. Do not lose pin. **See Figure 4.**
7. Slide driven magnet (4) over hex part on the back of the impeller, with the radius edge facing back of the impeller. A small amount of water soluble lubricant will help the magnet slide free. You may need to apply pressure to get over the end of the impeller hex. Make sure the pin (26) remains in place. The magnet will now hold the pin captive. **See Figure 5.**
8. Holding cup sub assembly in one hand, gently slide impeller/bearing assembly over the shaft and down to thrust washer. Allow magnet to settle against back of cup by placing cup back on the table as in item (1). **See Figure 6.**
9. Place the o-ring (9) over cup pilot in large radius section. **See Figure 7.**
10. Install drain plug (12) with o-ring (10) into casing (6). Drain plug should seat completely flush against casing boss.

### Read step 12 completely before proceeding!

11. Carefully take washer (11) and locate it in casing over standing lugs where shaft pilots into casing. Make sure washer stays centered with shaft bore. It is recommended, if application permits, to use a small amount of PTFE (teflon) paste between the washer and casing. This will form a temporary "bond" for assembly purposes. **See Figure 8.**
12. Install proper cutwater (18) into casing (6). **See Figure 9.**
13. Hold casing horizontally, keeping washer in place. Lift cup sub assembly horizontally with shaft facing casing. **See Figure 10.**
14. Gently slide shaft into washer and casing. Stop if there are any signs of misalignment. Casing/cup should go together until casing is contacting o-ring. **See Figure 11.** Make sure casing and cup "ears" are all correctly aligned so that they match up. Refer to the common "flat" ear in figure 12 for reference.

## MOTOR/DRIVE SUBASSEMBLY

**"CAUTION" Pump contains powerful rare earth magnets. Magnets can affect pacemakers, credit cards, and metallic objects. Failure to follow these assembly instructions could result in serious injury.**

1. Stand the motor (1) on its fan end, inspect shaft for debris and imperfections. Remove any if present.
2. Apply a small amount of Superlube ® lubricant to shaft.
3. Inspect the drive magnet (5) bore for any loose paint in the bore. Remove if necessary.
4. Check the fit of the shaft and key to drive magnet bore. Make sure the drive magnet installs and removes freely.
5. Remove drive magnet from the motor and set aside.
6. Bolt the adapter plate (2) to adapter (3) using 4 -1" x 3/8" bolts, washers (17), lock washers (23), and nuts (22).

Install nuts into hex area found in back of adapter plate. Torque bolts to 10 ft./lbs.

7. Using 4 -1/2" bolts (15) and washers (16), secure the adapter assembly to the motor. Orientation must be so that the "flat" ear on the adapter corresponds with the bottom "base" of the motor. **See Figure 12** for orientation picture. Torque bolts to 20 ft./lbs. each.
8. Install 2 set screws (25) into drive magnet (5). Do not allow set screws to protrude into shaft/key area.
9. Install drive magnet with set screws onto shaft of motor. Drive bell should be approximately 1/16" below adapter surface as shown in **Figure 13**. Check that disk (7) does not hit magnet when magnet is rotated with disk (7) in position.
10. Tighten 2 set screws with 1/8" hex wrench through weep hole in adapter (3). **See Figure 16 and 17.**
11. Install 3 -3/8"x 3" full thread screws (24) into adapter (3). These screws should be installed with the hex toward motor and threaded into 3 bosses on adapter (3). Screws should be fully extended almost bottoming as the hex nears the adapter. These screws will be used to lower the powerful magnet/cup assembly into the drive magnet assembly. **See Figure 14.**

## ASSEMBLY OF WET END TO MOTOR DRIVE SUBASSEMBLY

1. You should, by now, have assembled a wet end and a motor/magnet drive assembly. If not, go back and do so.
2. With both subassemblies complete, you will now look at the orientation of the cup (8) versus the adapter (3). There is a "flat" ear on both that corresponds. There is also 3 "ears" on the cup that correspond to the 3 bolts sticking out of your adapter.
3. For safety, put on gloves for the remainder of this assembly to prevent any possibility of pinching.
4. Remove the disk (7) from the adapter (3) and slide it onto the cup (8). Be careful, the disk is magnetic and will shift with the magnet inside the cup. The arched section of the disk should correspond with the back face of the cup. Make sure the 2 surfaces match.
5. Holding the wet end subassembly with the disk, lower the assembly until the 3 bolts contact the 3 bosses in the cup. Look carefully under the cup where the bolts made contact. Make sure the 3 bolts are rested inside the counter bores in the cup adjust or remove and replace if necessary. **See Figure 14.**
6. You will notice that the disk (7) has centered itself with the magnets. As you lower the assembly, you will need to make sure the disk seats into the counter bore in the adapter (3) properly.
7. Carefully lower the wet end by turning each of the 9/16" hex head 3/8"x 3" full thread bolts counter clockwise 2-3 turns each, in sequence. Continue until all 3 bolts are backed out and the cup contacts the adapter. **See Figure 15.**
8. Center and seat the cup on its counter bore on the adapter and make sure all bolt holes and bosses are aligned properly.
9. Install 6 - 3/8"x 3 3/4"bolts (20), washers (17) and nuts (22) through casing (6), resting the nuts in the adapter (3) back.
10. Tighten all 6 bolts in a star pattern and torque to 10ft./lbs. each.

**IMPORTANT!** With pump standing on fan end of motor, insert a long screw driver and use it to spin the impeller to make sure it spins freely.. If not, disassemble and check for bound parts.

11. Connect plumbing to pump. Mount pump and connect wiring. Check rotation direction of motor only after pump has been flooded. Rotation direction should be clockwise from far end of motor.
12. Start pump and check for leaks.

You have now completed the pump assembly.

**DISASSEMBLY:**

1. Disconnect power and plumbing, drain all fluid from pump.
2. Remove 6 - 3/8"x 3 " bolts (20), nuts (22), and washers (17).
3. Using 3 - 3/8"x 3" full thread bolts in adapter. Separate wet end by tightening these a few turns at a time. Do this in a circular sequence to slowly separate the assembly until all 3 bolts are fully extended. **See Figure 14 and 15.**
4. Holding cup/casing assembly with two hands, and securing the motor from moving, pull the cup/casing assembly away from the adapter/motor/drive magnet. **See Figure 11.**
5. Set the casing/cup assembly on the back of the cup flat on the table. Be cautious of metal on the bench that may be attracted by the powerful magnets inside the cup.

6. Lift the casing (6) off the cup vertically. Make sure that the washer (11) is not damaged. Set casing (6) and washers (11) aside.
7. If disk (7) is with cup assembly, remove it now.
8. Remove impeller assembly (13) and driven magnet (4) from cup gently to avoid damaging the silicon carbide shaft (14). **See Figure 6.**
9. Remove the other washer (11) from the shaft gently. **See Figure (2).**
10. Remove the shaft (14) from the cup (8) with a slight rocking motion if required. **See Figure 1.**
11. Remove o-ring (9) from cup. Replace if necessary.
12. Inspect all washers (11) and shaft (14) for damage. Replace if required.
13. Inspect impeller/bearing assembly for any damage. Remove magnet (4) and pin (26) and set aside.
14. Remove drive magnet (5) from motor by loosening 2 - 1/8" set screws through weep hole in adapter. Sethco removal tool part number 914P102543-680 is available if the drive magnet will not remove. **See Figure 16 and 17.**
15. Remove adapter/plate assembly by removing 4 - " bolts (15) from motor.
16. Inspect motor shaft and C face for corrosion or damage.
17. Separate the adapter (3) from the adapter plate (2) by removing 4 - 3/8" screws.
18. Inspect all parts. Replace if necessary.



FIGURE 1



FIGURE 2

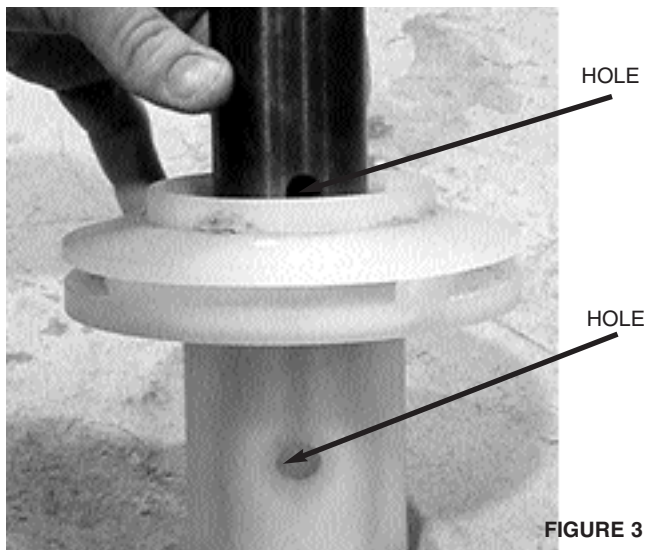

FIGURE 3

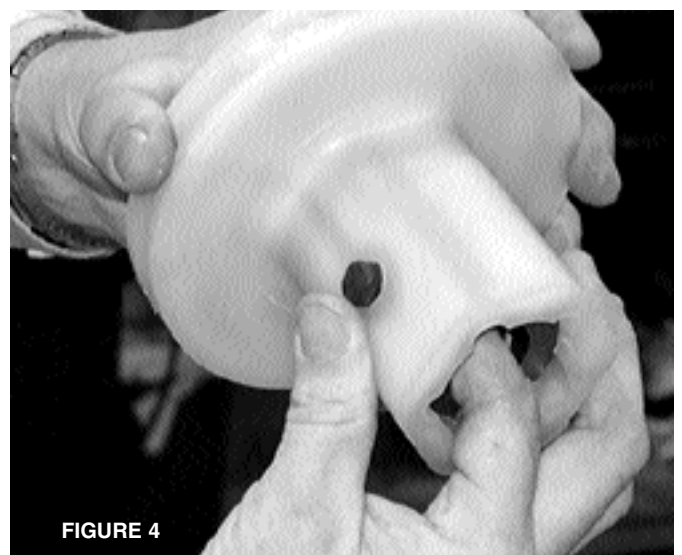

FIGURE 4





FIGURE 5



FIGURE 6

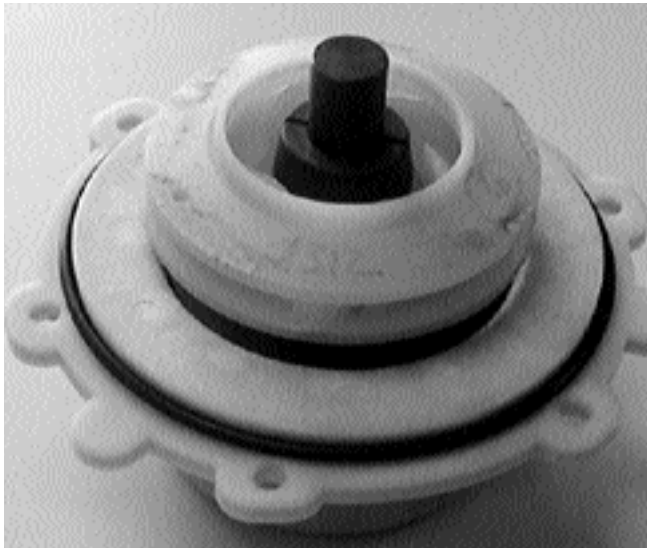

FIGURE 7

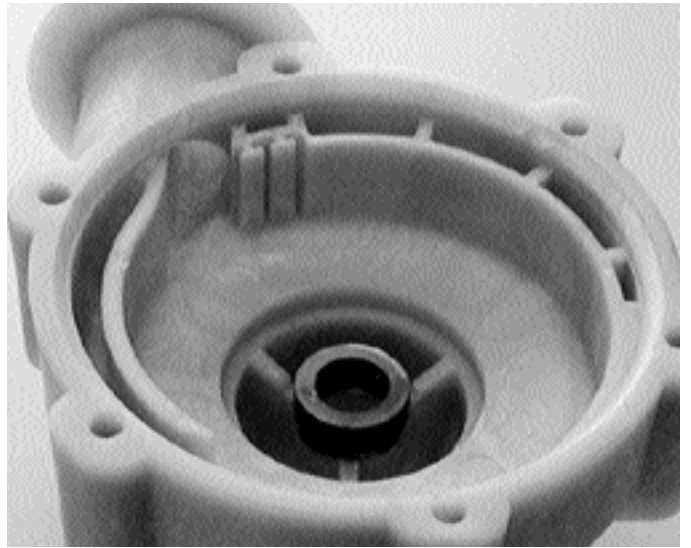

FIGURE 8

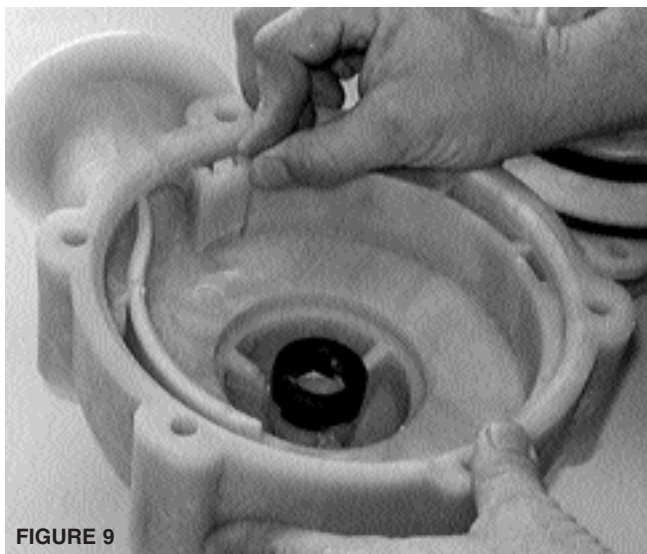

FIGURE 9

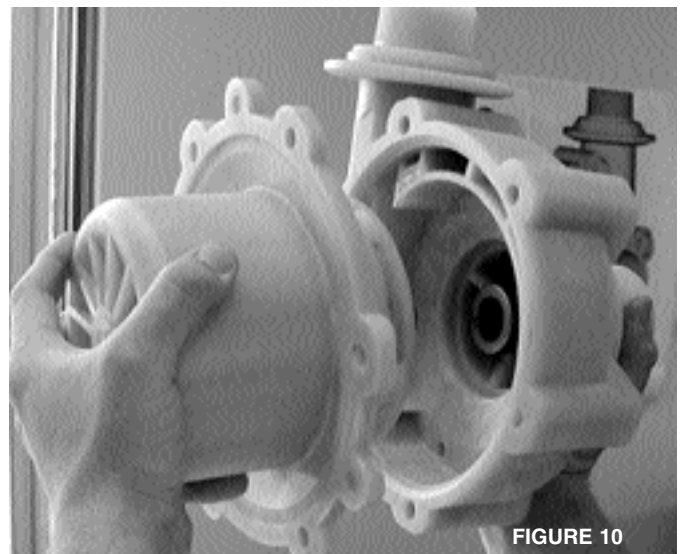

FIGURE 10

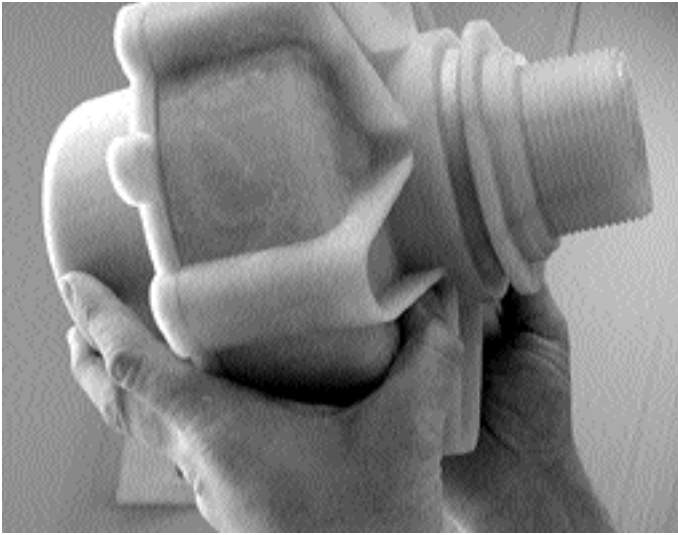
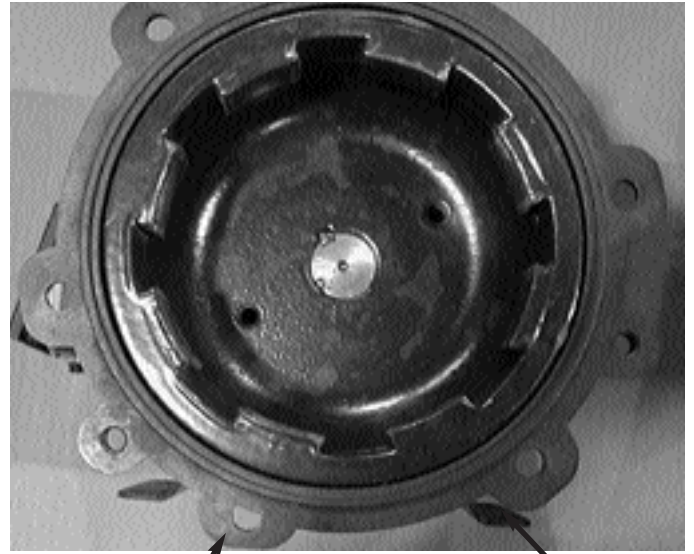

FIGURE 11



BOTTOM FLAT BOSS

FIGURE 12

MOTOR FEET

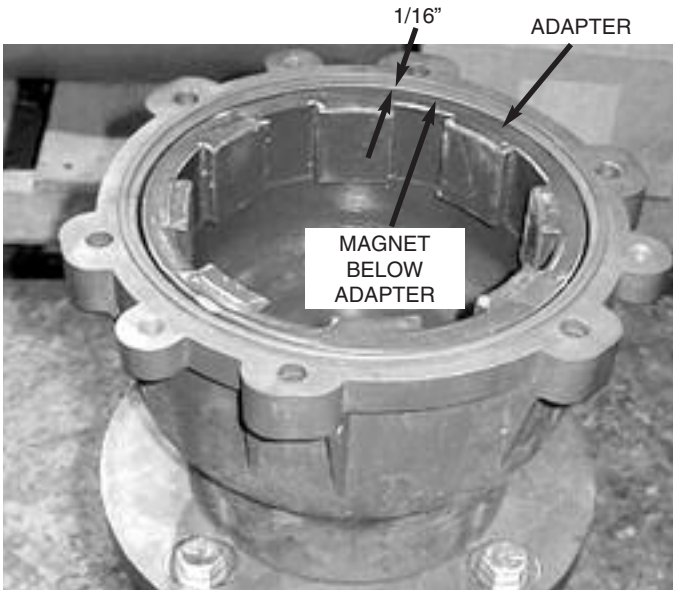

FIGURE 13

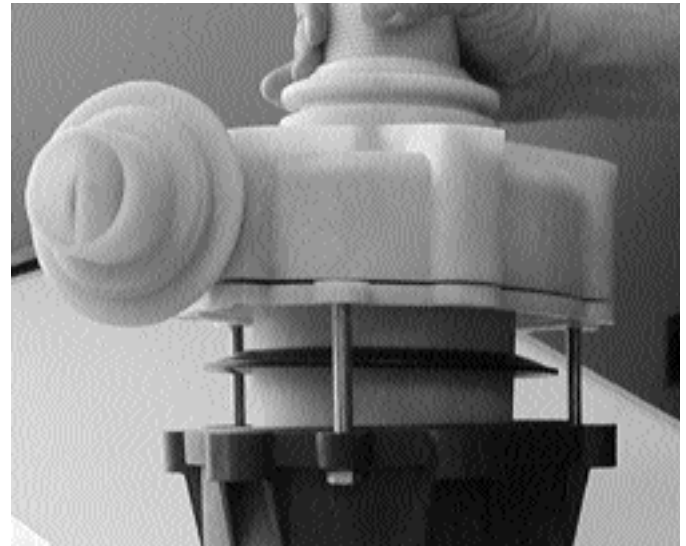

FIGURE 14

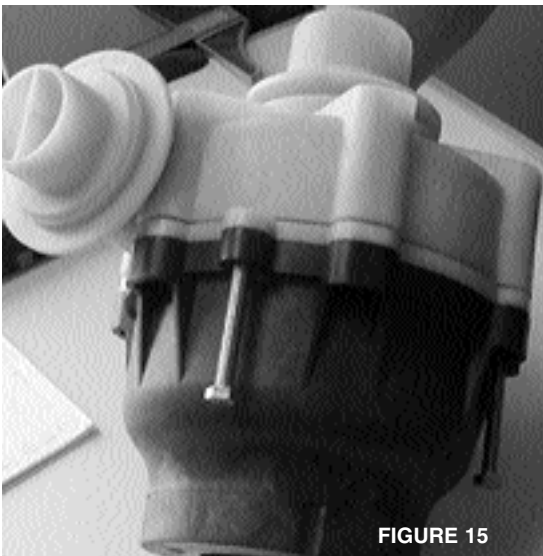

FIGURE 15



FIGURE 16



FIGURE 17

**SELF PRIMING  
MAGNETIC-DRIVE  
SEAL-LESS PUMP**

PARTS LIST

OPERATION INSTRUCTIONS

*June 1, 2002*

**CECO Sethco**

700 Emlen Way • Telford, PA 18969

Phone: 215.723.8155

Email: [infofhs@onececo.com](mailto:infofhs@onececo.com)

[www.cecoenviro.com](http://www.cecoenviro.com)

*For high volume transfer  
of most acids, alkalies, caustics,  
bleaches, sea water, solvents  
and many other harsh environments*

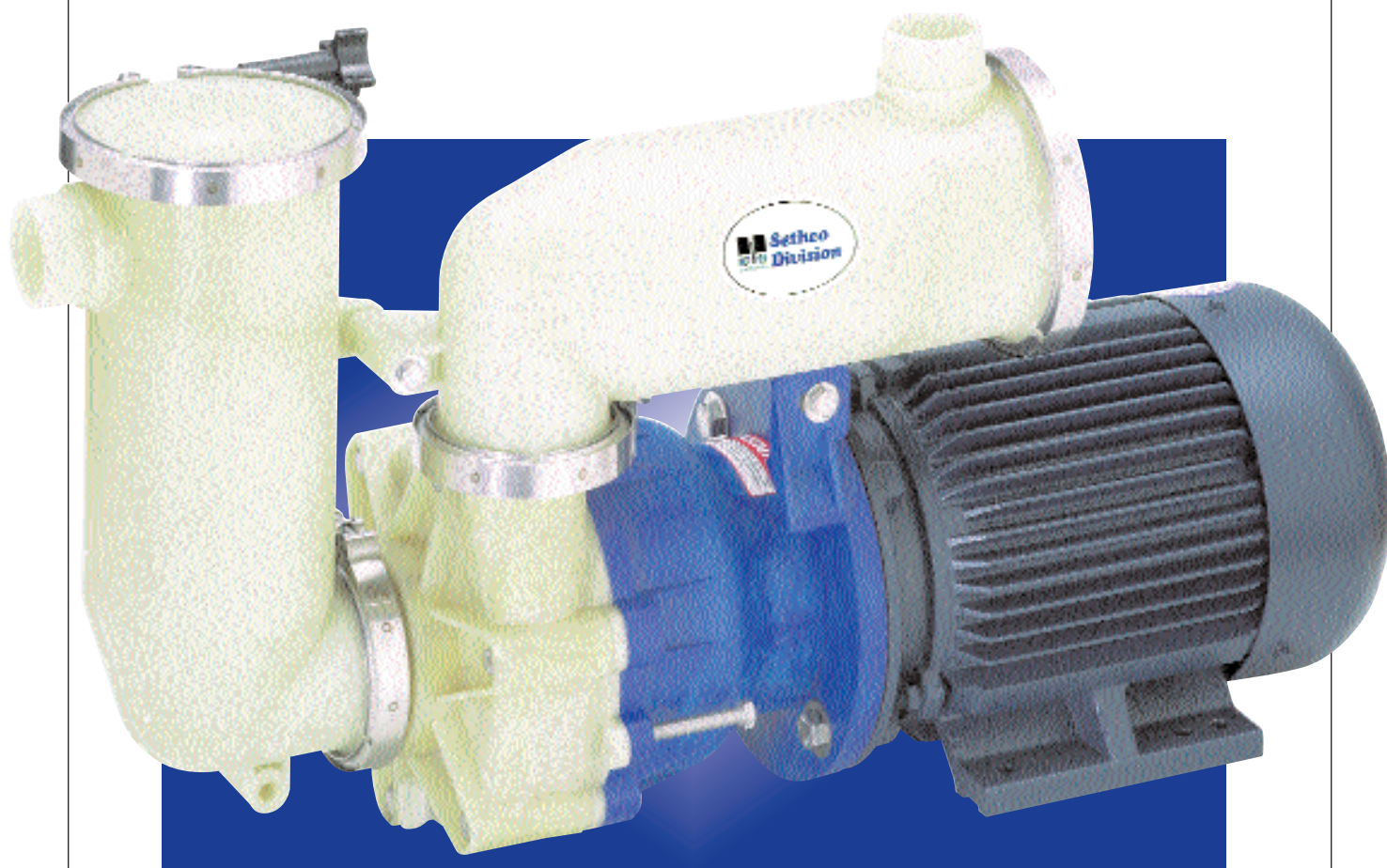

**WARNING: PUMP CONTAINS POWERFUL  
MAGNETS. EXTREME CARE MUST BE USED  
DURING ASSEMBLY AND  
DISASSEMBLY TO AVOID INJURY.**

# OPERATING INSTRUCTIONS

## **YOU WILL NEED THE FOLLOWING TOOLS**

1. 3/8" ratchet
2. 3/8" 6" length extension
3. Torque wrench
4. 9/16" socket
5. 3/4" socket
6. 3/4" open end wrench
7. 1/8" hex allen wrench
8. 7/16" deep socket
9. Teflon paste (optional)
10. Sethco removal tool (part number: 914P102543-680 (optional))

## **INSTALLATION**

Allow sufficient head room and floor space for the addition of priming liquid and for proper inspection and maintenance.

## **PIPING**

All piping must be supported independently of the pump. The piping should always line up naturally with the pump. Never draw or force the piping to the suction or discharge of the pump. All installations should be properly designed for changes in ambient operating temperatures. Omission of this could result in severe strain transmitted to the pump. The piping should be as short and direct as possible. Avoid all unnecessary elbows, bends, and fittings, as they increase friction losses in the piping.

## **SUCTION PIPING**

The length of the suction pipe should be as short as possible to prevent excessively long priming time, as priming times are directly proportional to suction piping volumes. **SUCTION PIPING MUST BE AIR TIGHT OR PUMP WILL NOT PRIME. DO NOT INSTALL ANY TYPE OF CHECK VALVE IN THE SUCTION PIPE.**

## **DISCHARGE PIPING**

A valve in the discharge line should be of a design to allow throttling or flow control. Centrifugal pumps should never be throttled on the suction side.

**THE DISCHARGE VALVE MUST BE OPEN AND THE DISCHARGE PIPING VENTED DURING THE PRIMING CYCLE TO ALLOW THE AIR EVACUATED FROM THE SUCTION PIPING TO ESCAPE.**

If a check valve is used in the discharge piping it must be equipped with an air bleed bypass or an air bleed return to the pumped liquid source. If you are not consult factory.

## **INITIAL START UP**

On first start up, and any time motor is reconnected to an electrical outlet, check direction of motor rotation as follows:

1. Fill pump with liquid as directed in priming instructions below.

2. Turn switch "on" and then "off" immediately. Observe rotation. It should be in the direction of the arrow on motor or pump (counterclockwise when looking at pump end of motor).
3. To reverse rotation refer to instructions on motor.

## **PRIMING AND STARTING**

Check to be sure suction and discharge valves are open. Also be sure discharge piping is vented and suction piping is submerged in the fluid to be pumped. Remove clamp (30) and cover (31). Fill primer chamber (6) to inlet with 2 quarts of priming fluid. Reinstall the cover (1) and secure the clamp (30). Start the pump. Initially, air will be pumped from the suction piping. When all the air is evacuated, the unit will pump liquid.

## **TROUBLESHOOTING**

### **A. Pump will not prime or insufficient liquid delivered:**

1. Air leakage in suction piping.
2. Suction lift too high or insufficient suction pressure.
3. Impeller, casing, suction pipe or strainer plugged with solids
4. Wrong rotation.
5. Magnetic couple slipping.

### **B. Not enough pressure:**

1. Speed too low.
2. Air or gases in the liquid.
3. Check impeller diameter.
4. Mechanical defects (impeller clearance too great: impeller damaged).
5. Wrong rotation.
6. Pressure gauge in the wrong place, (or defective gauge) .

### **C. Pump takes too much power:**

1. Speed too high.
2. Head lower than rating; pumping beyond design point.
3. Liquid heavier than specified; check viscosity and specific gravity.
4. Mechanical defects (rotating element rubbing).

### **D. Pump is noisy:**

1. Hydraulic noises—cavitation, insufficient suction pressure.
2. Mechanical defects (rotating parts are binding, loose or broken).

### **E. Pump leaks:**

1. Teflon o-rings are subject to creep. When a leak is detected, stop the pump and check the clamps and fasteners to be sure they are secure. Should the leak continue, secure the pump and inspect all the components for cracks and wear.

# PARTS LIST

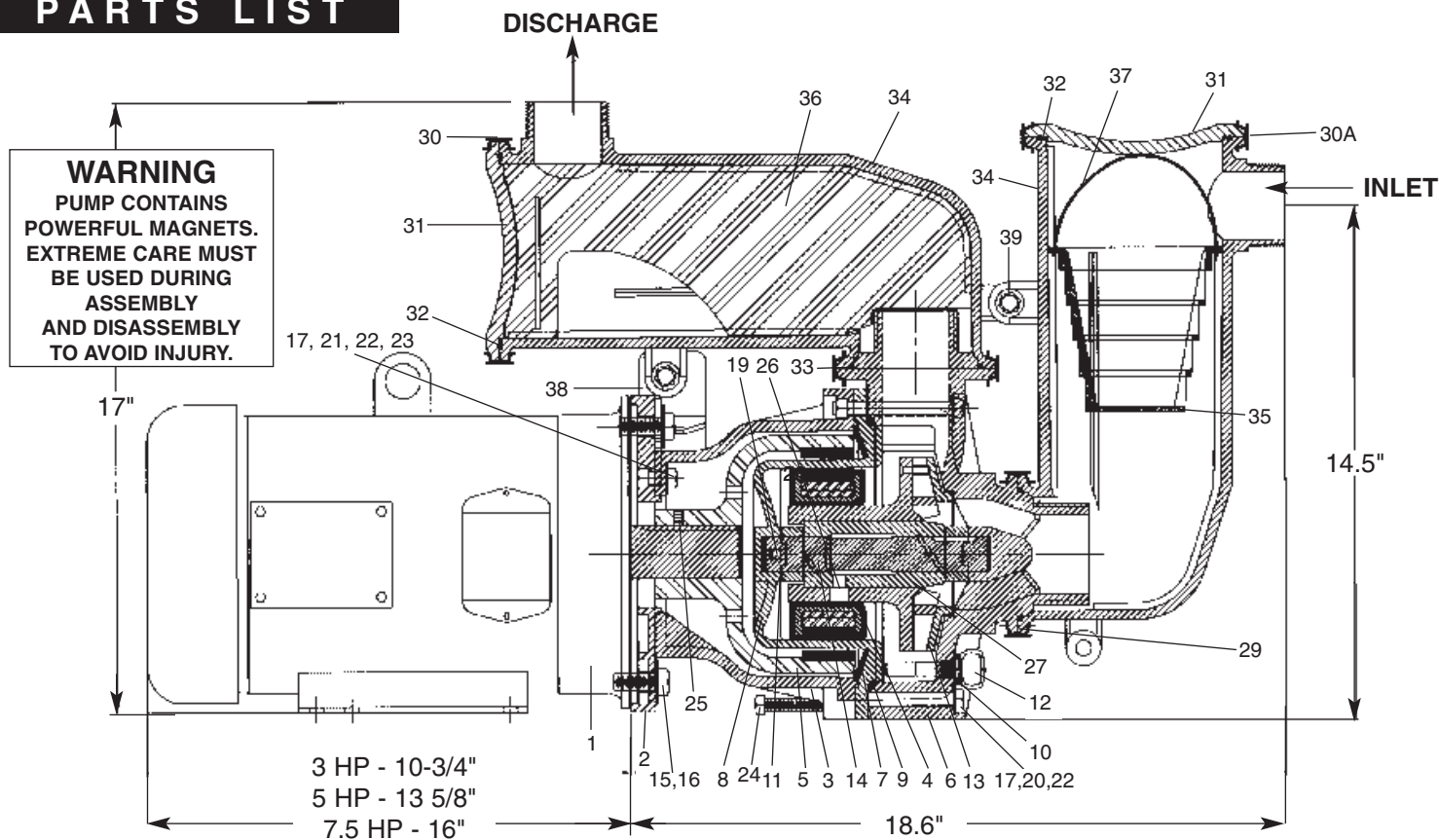

POLYPROPYLENE MODELS

KYNAR MODELS

ITEM	DESCRIPTION	QTY.	MATERIAL	PART NUMBER	MATERIAL	PART NUMBER
1	Motor	1	Various	Consult factory	Various	Consult factory
2	Adapter Plate	1	Noryl	010P400355-513	Noryl	010P400355-513
3	Adapter	1	Noryl	010P400356-513	Noryl	010P400356-513
4	Magnet Assembly	1	PVDF	562P400360-383	Kynar	562P400360-383
5a	Magnetic Drive, 1-1/8"	1	Various	561P4003622-362	Various	561P4003622-362
5b	Magnetic Drive, 1-3/8"	1	Various	562P4003623-362	Various	561P4003622-362
6	Casing	1	Polypro	133P400357-576	Kynar	133P400357-383
7	DISK	1	Powder Coated Stainless Steel	250P400372-685	Powder Coated Stain. Steel	250P400372-685
8	Cup	1	Polypro	180P400381-569	Kynar	180P400385-389
9	O-ring	1	Viton	590P2366-830	Viton	590P2366-830
10	O-ring	1	Viton	590P2113-830	Viton	590P2113-830
11	Thrust Washer	2	Silicone Carbide	990P202080-755	Silicone Carbide	990P202080-755
12	Drain Plug	1	Polypro	660P2020652-576	Kynar	660P2020652-383
13	Impeller Assembly	1	Graphite/Polypro	consult factory	Graphite/Kynar	consult factory
14	Shaft	1	Silicone Carbide	850P202079-755	Silicone Carbide	850P202079-755
15	Screw 1/2" x 1-1/2"	4	Stainless Steel	790P0413104-680	Stainless Steel	790P041302-680
16	Washer 1/2"	4	Stainless Steel	990P04102-680	Stainless Steel	990P04102-680
17	Washer 3/8" x 7/8"	14	Stainless Steel	990P0307-680	Stainless Steel	990P0307-680
18	Cutwater (Not shown)	1	Polypro	183P4003613-576	Kynar	183P4003613-383
19	Pin (Not shown)	1	Ceramic	682P102526-150	Ceramic	682P102526-150
20	Bolt 3/8-16 x 3-3/4"	7	Stainless Steel	790P0316306-680	Stainless Steel	790P0316306-680
21	Bolt 3/8-16 x 1"	5	Stainless Steel	790P03161-680	Stainless Steel	790P03161-680
22	Nut 3/8-16	12	Stainless Steel	610P0316-680	Stainless Steel	610P0316-680
23	Lockwasher 3/8"	6	Stainless Steel	540P03-680	Stainless Steel	540P03-680
24	Bolt 3/8"-16 x 3" (full thread)	3	Stainless Steel	790P031632-680	Stainless Steel	790P031632-680
25	Set Screw 1/4-20 x 1/2"	2	Steel	800P022004-720	Steel	800P022004-720
26	Impeller Pin	1	Kynar	682P102527-383	Kynar	682P102527-383
27	Bearing	1	Carbon	080P202078-100	Carbon	080P202078-100
27	Bearing	1	Silicone Carbide	080P202078-755	Silicone Carbide	080P202078-755
28	Impeller Assembly		See Table A on next page	—	See Table A on next page	—
29	Clamp (Chamber to Casing)	2	Stainless Steel	130P202082-680	Stainless Steel	130P202082-680
30	Clamp (Discharge Chamber)	1	Stainless Steel	130P202081-680	Stainless Steel	130P202081-680
30A	Clamp (Inlet Chamber)	1	Stainless Steel	130P2020811-680	Stainless Steel	130P2020811-680
31	Cover	2	Polypro	140P301426-576	Kynar	140P301426-383
32	O-ring	2	Viton	590P2252-830	Viton	590P2252-830
33	O-ring	2	Viton	590P2238-830	Viton	590P2238-830
34	Priming Chamber	2	Polypro	662P400359-576	Kynar	662P400359-383
35	Basket Strainer	1	Polypro	031P400365-580	Kynar	031P400365-383
36	Baffle	1	Polypro	033P400358-580	Kynar	033P400358-384
37	Handle	1	Polypro	391P201350-576	Kynar	391P201350-384
38	Bracket	1	Noryl	050P400375-513	Noryl	050P400375-513
39	Bolt 3/8 - 16 -3-1/2"	2	Stainless Steel	790P0316304-680	Stainless Steel	790P0316304-680

NOTE 1: POLYPROPYLENE IS GLASS REINFORCED. O-RINGS ARE AVAILABLE IN EPDM AND TEFLON - CONSULT FACTORY

**IMPELLER MODEL # ASSEMBLY BEARING MATERIAL**

IMPELLER MATERIAL	MODEL	CARBON	SILICONE CARBIDE
POLYPRO	2510	CONSULT FACTORY	CONSULT FACTORY
	2525	CONSULT FACTORY	CONSULT FACTORY
	2550	CONSULT FACTORY	CONSULT FACTORY
KYNAR	2510	CONSULT FACTORY	CONSULT FACTORY
	2525	CONSULT FACTORY	CONSULT FACTORY
	2550	CONSULT FACTORY	CONSULT FACTORY

Torque Specs	
Casting - Cup	10 ft. lbs.
Adapter - Plate	10 ft. lbs.
Adapter - Motor	20 ft. lbs.

**ASSEMBLY: WET END SUBASSEMBLY**

1. Lay cup (8) flat on table. Open end up.
2. Insert pin (19) into shaft (14) (unless pin is pre-molded in shaft).
3. Slide pin/shaft assembly into cup (8) with the pin guiding into the slot in the cup. **See Figure 1.**
4. Take one washer (11) with the cut section down and gently slide it over shaft. Slot in washer should engage standing section in cup. **See Figure 2.**
5. Press bearing (27) into impeller (28) with the guide hole in bearing lined up with the guide hole in the impeller. **See Figure 3.**
6. Place pin (26) into hole between bearing and impeller precisely pressed together. Do not lose pin. **See Figure 4.**
7. Slide driven magnet (4) over hex part on the back of the impeller, with the radius edge facing back of the impeller. A small of water soluble lubricant will help the magnet slide free. You may need to apply pressure to get over the end of the impeller hex. Make sure the pin (26) remains in place. The magnet will now hold the pin captive. **See Figure 5.**
8. Holding cup sub assembly in one hand, gently slide impeller/bearing assembly over the shaft and down to thrust washer. Allow magnet to settle against back of cup by placing cup back on the table as in item (1). **See Figure 6.**
9. Place the o-ring (9) over cup pilot in large radius section. **See Figure 7.**
10. Install drain plug (12) with o-ring (10) into casing (6). Drain plug should seat completely flush against casing boss.
11. Install proper cutwater (18) into casing (6). **See Figure 9.**

**Read step 12 completely before proceeding!**

12. Carefully take washer (11) and locate it in casing over standing lugs where shaft pilots into casing. Make sure washer stays centered with shaft bore. It is recommended, if application permits, to use a small amount of PTFE (teflon) paste between the washer and casing. This will form a temporary "bond" for assembly purposes. **See Figure 8.**
13. Hold casing horizontally, keeping washer in place. Lift cup sub assembly horizontally with shaft facing casing. **See Figure 10.**
14. Gently slide shaft into washer and casing. Stop if there are any signs of misalignment. Casing/cup should go together until casing is contacting o-ring. **See Figure 11.** Make sure casing and cup "ears" are all correctly aligned so that they match up. Refer to the common "flat" ear in figure 12 for reference.

**MOTOR/DRIVE SUBASSEMBLY**

**"CAUTION" Pump contains powerful rare earth magnets. Magnets can affect pacemakers, credit cards, and metal-**

**lic objects. Failure to follow these assembly instructions could result in serious injury.**

1. Stand the motor (1) on its fan end, inspect shaft for debris and imperfections. Remove any if present.
2. Apply a small amount of Superlube ® lubricant to shaft.
3. Inspect the drive magnet (5) bore for any loose paint in the bore. Remove if necessary.
4. Check the fit of the shaft and key to drive magnet bore. Make sure the drive magnet installs and removes freely.
5. Remove drive magnet from the motor and set aside.
6. Bolt the adapter plate (2) to adapter (3) using 4 -1" x 3/8" bolts, washers (17), lock washers (23) , and nuts (22). Install nuts into hex area - found in back of adapter plate. Torque bolts to 10 ft./lbs.
7. Using 4-1/2" bolts (15) and washers (16), secure the adapter assembly to the motor. Orientation must be so that the "flat" ear on the adapter corresponds with the bottom "base" of the motor. **See Figure 12** for orientation picture. Torque bolts to 20 ft./lbs. each. On bolt at 2 o'clock position, install bracket (38) as shown in Figure 24. Leave this bolt hand tight for now.
8. Install 2 set screws (25) into drive magnet (5). Do not allow set screws to protrude into shaft/key area.
9. Install drive magnet with set screws onto shaft of motor. Drive bell should be approximately 1/16" below adapter surface as shown in **Figure 13**. Check that disk (7) does not hit magnet when magnet is rotated with disk (7) in position.
10. Tighten 2 set screws with 1/8" hex wrench through weep hole in adapter (3). **See Figure 16 and 17.**
11. Install 3-3/8" x 3" full thread screws (24) into adapter (3). These screws should be installed with the hex toward motor and threaded into 3 bosses on adapter (3). Screws should be fully extended almost bottoming as the hex nears the adapter. These screws will be used to lower the powerful magnet/cup assembly into the drive magnet assembly. **See Figure 14.**

**ASSEMBLY OF WET END TO MOTOR DRIVE SUBASSEMBLY**

1. You should, by now, have assembled a wet end and a motor/magnet drive assembly. If not, go back and do so.
2. With both subassemblies complete, you will now look at the orientation of the cup (8) versus the adapter (3). There is a "flat" ear on both that corresponds. There is also 3 "ears" on the cup that correspond to the 3 bolts sticking out of your adapter.
3. For safety, put on gloves for the remainder of this assembly to prevent any possibility of pinching.
4. Remove the disk (7) from the adapter (3) and slide it onto the cup (8). Be careful, the disk is magnetic and will shift with the magnet inside the cup. The arched section of the disk should correspond with the back face of the cup. Make sure the 2 surfaces match.
5. Holding the wet end subassembly with the disk, lower the assembly until the 3 bolts contact the 3 bosses in the cup. Look carefully under the cup where the bolts made

6. You will notice that the disk (7) has centered itself with the magnets. As you lower the assembly, you will need to make sure the disk seats into the counter bore in the adapter (3) properly.
7. Carefully lower the wet end by turning each of the 9/16" hex head 3/8" x 3" full thread bolts counter clockwise 2-3 turns each, in sequence. Continue until all 3 bolts are backed out and the cup contacts the adapter.  
See **Figure 15**.
8. Center and seat the cup on its counter bore on the adapter and make sure all bolt holes and bosses are aligned properly.
9. Install 6-3/8" x 3-3/4" bolts (20), washers (17) and nuts (22) through casing (6), resting the nuts in the adapter (3) back.
10. Tighten all 6 bolts in a star pattern and torque to 10ft./lbs. each.  
**IMPORTANT!** With pump standing on fan end of motor, insert a long screw driver and use it to spin the impeller to make sure it spins freely.. If not, disassemble and check for bound parts.

#### SELF PRIMING ASSEMBLY:

1. Install handle (37) into basket strainer (35).
2. Install basket strainer/handle into one priming chamber (34). **See Figure 20**. This will be the inlet priming chamber.
3. Install o-ring (32) into groove in priming chamber. See Figure 19. Install cover (31) and clamp (30) onto chamber. **See Figure 22**. Set assembly aside.
4. Install baffle (36) into priming chamber (34). Make sure that the contour of the baffle end mates with matching contour inside priming chamber. Baffle should be captured between 2 standing rails on each side. **See Figure 19** for clarification if necessary.
5. Install o-ring (32) into groove in priming chamber. See **Figure 21**. Install cover (31) and clamp (30) onto chamber. **See Figure 22**. This assembly will be the priming chamber assembly.
6. Install o-rings (33) on both the pump casing inlet and discharge nipples. See figure 18 for proper location.
7. Install inlet priming chamber (with basket strainer) over 2-1/2" inlet thread. Chamber should seat nearly flat to the flange face on the casing. Use band clamp (29) and a 7/16" deep socket or nut driver to clamp the priming chamber to the casing. Leave priming chamber loose or movable for now. **See Figure 23**.
8. Install discharge priming chamber (with baffle) over 2" discharge thread. Chamber should seat nearly flat against casing flange. Use band clamp (29) and a 7/16" deep socket or nut driver to clamp the priming chamber to the casing. Leave the priming chamber loose or movable for now.
9. Rotate discharge chamber assembly until mounting bracket (38) site slat against chamber bracket. See Figure 25. Install 3/8" x 1" bolt (21), washers (17), lockwasher (23), and nut (22). Do not tighten at this time.
10. Rotate inlet chamber until the chamber bracket on it contacts the long boss on the discharge chamber. See Figure 24. Use 3/8" x 3-3/4" long bolt (39) with washers (17), lockwasher (23), and nut (22). Do not tighten at this time.
11. Check that both priming chambers have not shifted from their flange faces. Tighten band clamps (29) on each using 7/16" deep socket.
12. Now tighten both 3/8" bolts (39) and (21) using a 9/16" socket. Torque to 10 ft./lbs.
13. Tighten the last 1/2' bolt using a 3/4" socket. Torque to 10 ft./lbs.
14. Connect plumbing to pump. Remove inlet priming chamber cover (31) to add fluid. Close cover and check rotation of motor. Rotation should be clockwise from fan end of motor. Start pump and check for leaks.
15. You have now completed the pump assembly.

#### DISASSEMBLY:

1. Disconnect power and plumbing, drain all fluid from pump.
2. Remove bolt (39), washers (17), nut (22), and lockwasher (23) using 9/16" wrench and socket. See Figure 22.
3. Remove short bolt (21), washer (17), nut (22), and lockwasher (23) using 9/16" wrench and socket. See Figure 25 and 26.
4. Loosen clamp (33) on discharge chamber (34) using a 7/16" deep socket or nut driver. See Figure 23.
5. Remove discharge chamber (34) and o-ring (33) from casing.
6. Loosen clamp (30) on discharge chamber using a 7/16" deep socket or nut driver. Remove cover (31) and baffle (36) from chamber. See Figure 19 and 22.
7. Loosen clamp (33) on inlet chamber (34) using a 7/16" deep socket or nut driver. See Figure 23.
8. Remove inlet chamber (34) and o-ring (33) from casing.
9. Loosen clamp (30) on inlet chamber (34) using a 7/16" deep socket or nut driver. Remove cover (31) and strainer basket/handle (35 & 37). See Figure 20 and 22.
10. Loosen 1-1/2" bolt (15) using a 3/4" wrench. Loosen only the bolt that is holding the bracket (38) in place. Remove bracket and set aside.
11. Remove 6 - 3/8"x 3-3/4" bolts (20), nuts (22), and washers (17).
12. Using 3-3/8"x 3" full thread bolts in adapter. Separate wet end by tightening these a few turns at a time. Do this in a circular sequence to slowly separate the assembly until all 3 bolts are fully extended. See Figure 14 and 15.
13. Holding cup/casing assembly with two hands, and securing the motor from moving, pull the cup/casing assembly away from the adapter/motor/drive magnet. See Figure 11.
14. Set the casing/cup assembly on the back of the cup flat on the table. **Be cautious of metal on the bench that may be attracted by the powerful magnets inside the cup.**
15. Lift the casing (6) off the cup vertically. Make sure that the washer (11) is not damaged. Set casing (6) and washers (11) aside.
16. If disk (73) is with cup assembly, remove it now.
17. Remove impeller assembly (13) and driven magnet (4) from cup gently to avoid damaging the silicon carbide shaft (14). See Figure 6.
18. Remove the other washer (11) from the shaft gently. See Figure 2.
19. Remove the shaft (14) from the cup (8) with a slight rocking motion if required. See Figure 1.
20. Remove o-ring (9) from cup. Replace if necessary.
21. Inspect all washers (11) and shaft (14) for damage. Replace if required.
22. Inspect impeller/bearing assembly for any damage. Remove magnet (4) and pin (26) and set aside.
23. Remove drive magnet (5) from motor by loosening 2 -1/8" set screws through weep hole in adapter. Sethco removal tool part number 91 4P 102543-680 is available if the drive magnet will not remove. See Figure 16 and 17.
24. Remove adapter/plate assembly by removing 4 -1/2" bolts (15) from motor.
25. Inspect motor shaft and C face for corrosion or damage.
26. Separate the adapter (3) from the adapter plate (2) by removing 4 -3/8" screws.



FIGURE 1



FIGURE 2

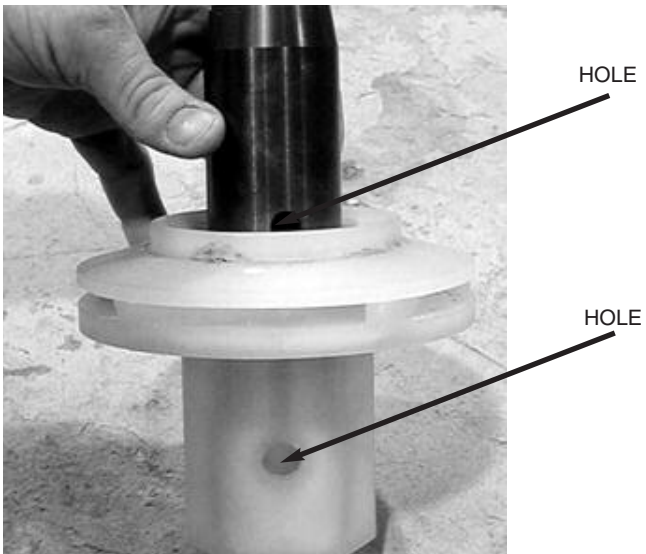

FIGURE 3



FIGURE 4



FIGURE 5



FIGURE 6





FIGURE 7

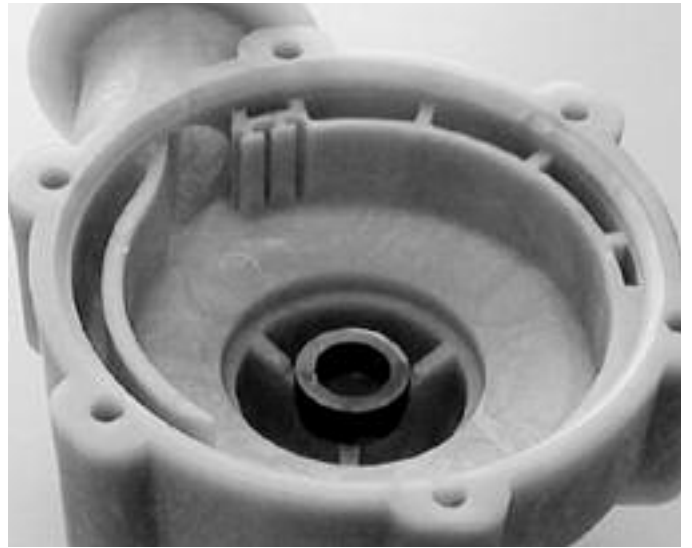

FIGURE 8



FIGURE 9

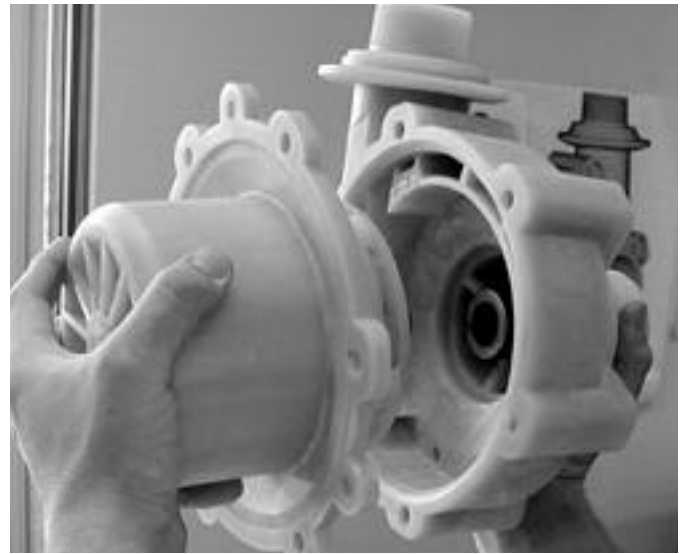

FIGURE 10



FIGURE 11



BOTTOM FLAT BOSS

FIGURE 12

MOTOR FEET

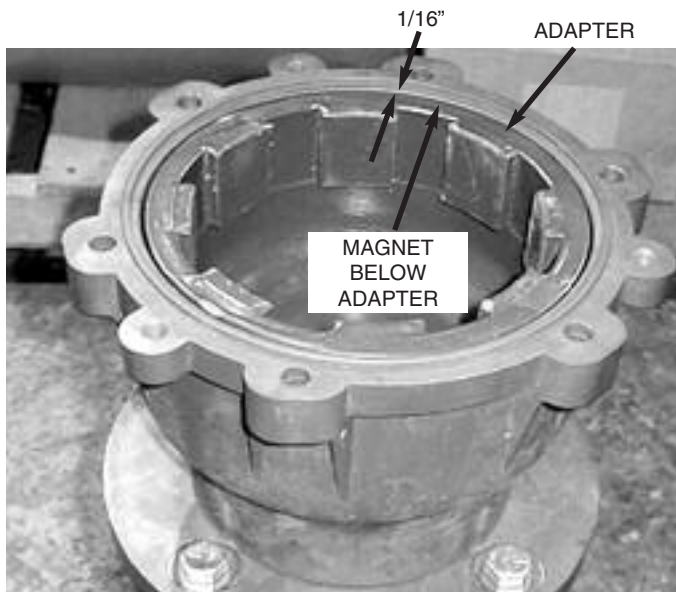

FIGURE 13

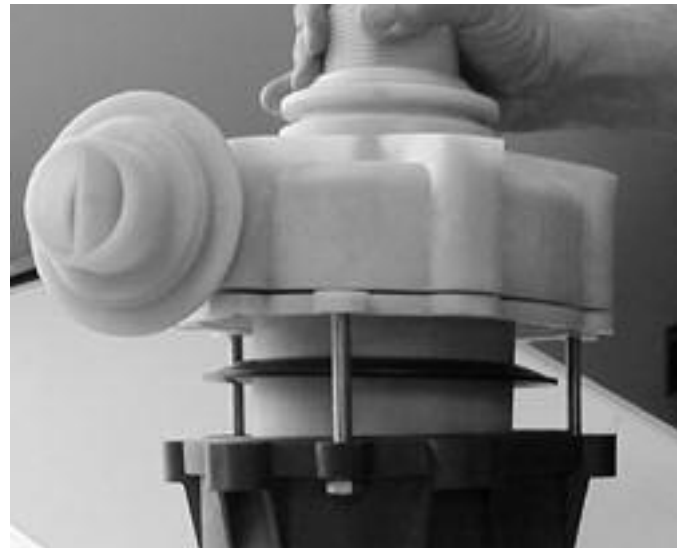

FIGURE 14



FIGURE 15



FIGURE 16



FIGURE 17

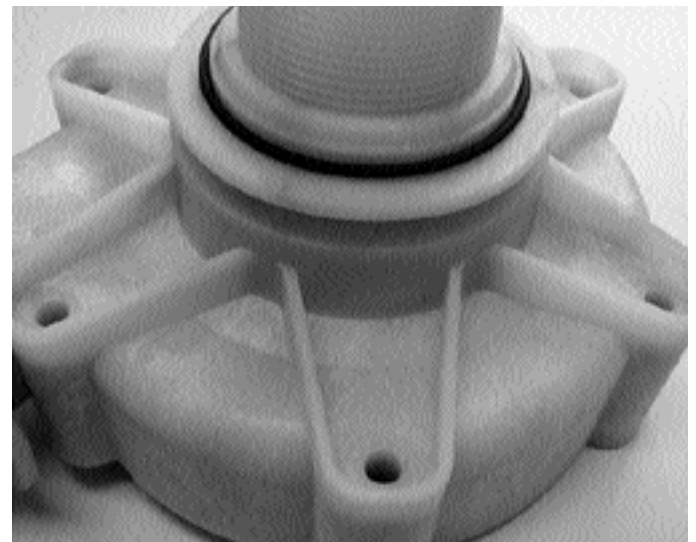

FIGURE 18

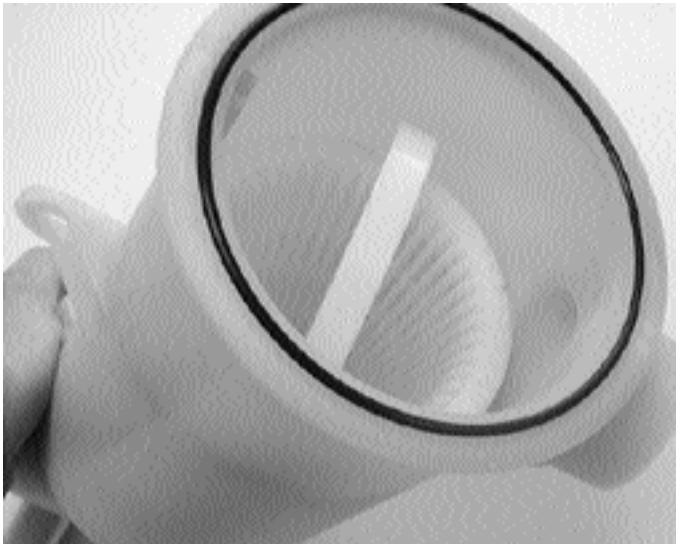

FIGURE 19

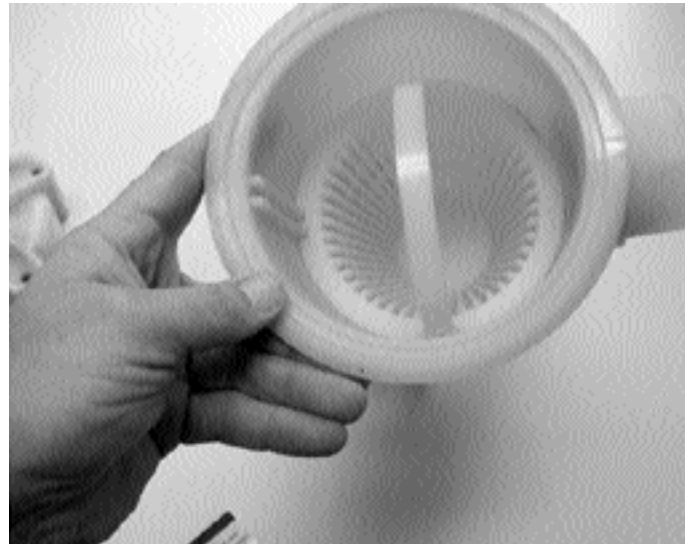

FIGURE 20

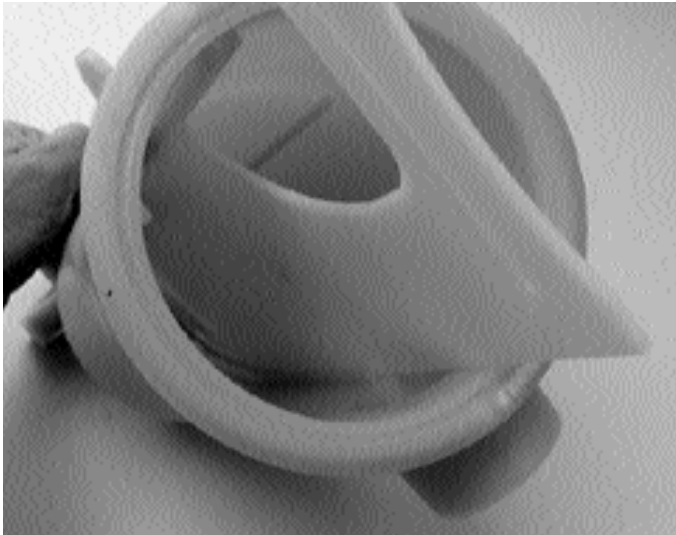

FIGURE 21

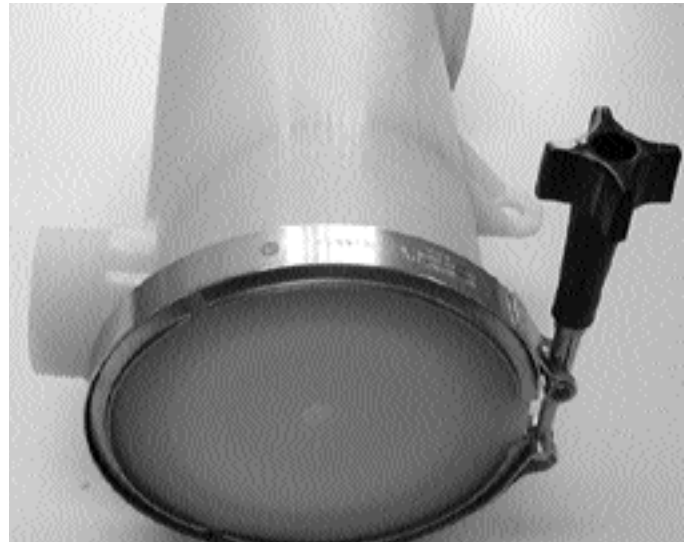

FIGURE 22

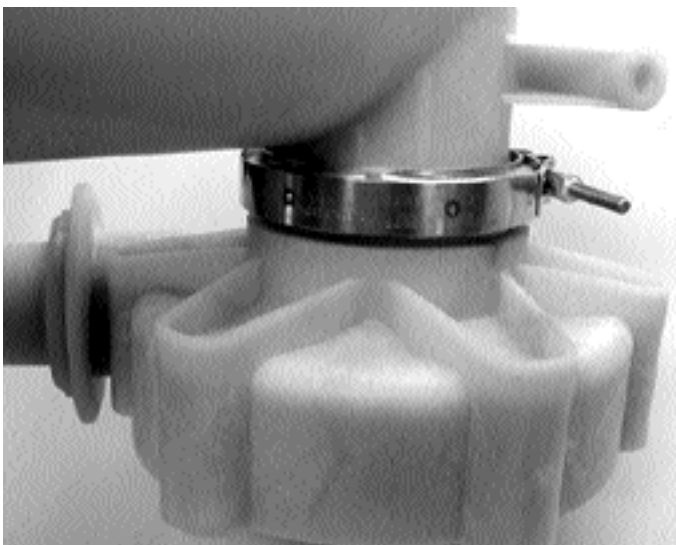

FIGURE 23

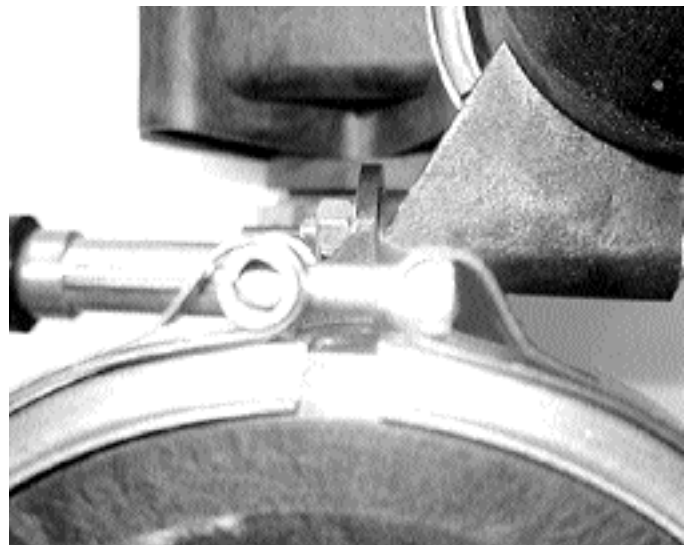

FIGURE 24

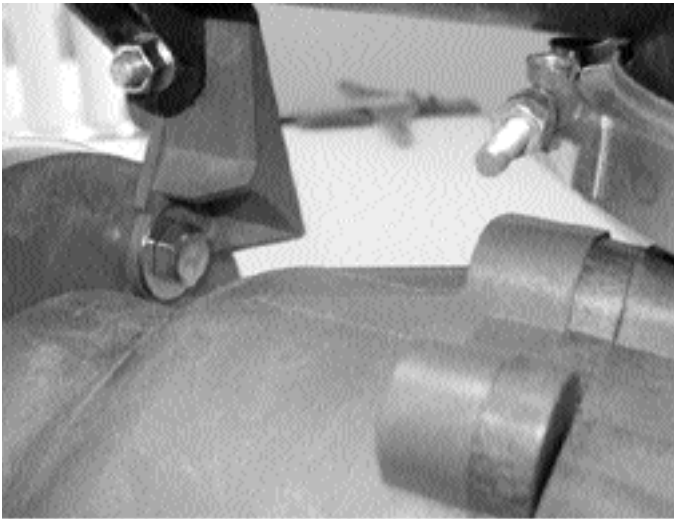

FIGURE 25

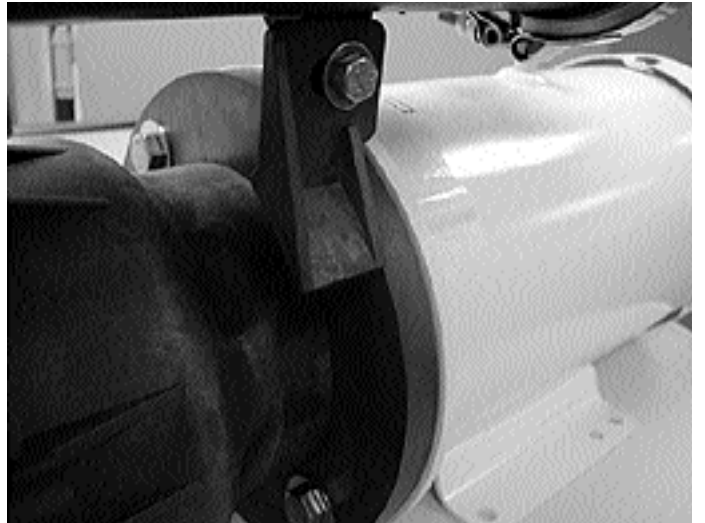

FIGURE 26



FIGURE 27



FIGURE 28